

RCS-9000F GTX1080 USER Manual

Intel® Xeon®/Core™ i7 GPU Computing System with NVIDIA® GeForce® GTX1080
Workstation-grade Performance, Expandable, Independent Graphics

Record of Revision

Version	Date	Page	Description	Remark
1.00	2018/04/02		Official Release	
1.10	2021/03/22	3, 5, 7, 9, 11, 13, 15, 17, 19, 21, 23, 25, 37	Update	

Disclaimer

This manual is released by Vecow Co., Ltd. for reference purpose only. All product offerings and specifications are subject to change without prior notice. It does not represent commitment of Vecow Co., Ltd. Vecow shall not be liable for direct, indirect, special, incidental, or consequential damages arising out of the use of the product or documentation or any infringements upon the rights of third parties, which may result from such use.

Declaration of Conformity

- FCC** This equipment has been tested and found to comply with the limits for a Class A digital device, pursuant to part 15 of the FCC Rules. These limits are designed to provide reasonable protection against harmful interference when the equipment is operated in a commercial environment. This equipment generates, uses, and can radiate radio frequency energy, and if it is not installed and used in accordance with the instruction manual, it may cause harmful interference to radio communications. Operation of this equipment in a residential area is likely to cause harmful interference in which case the user will be required to correct the interference at his own expense.
- CE** The products described in this manual complies with all applicable European Union (CE) directives if it has a CE marking. For computer systems to remain CE compliant, only CE-compliant parts may be used. Maintaining CE compliance also requires proper cable and cabling techniques.

Copyright and Trademarks

This document contains proprietary information protected by copyright. No part of this publication may be reproduced in any form or by any means, electric, photocopying, recording or otherwise, without prior written authorization by Vecow Co., Ltd. The rights of all the brand names, product names, and trademarks belong to their respective owners.

Order Information

Part Number	Description
RCS-9430F-GTX1080	RCS-9400F, NVIDIA® GeForce® GTX1080, 2 GigE LAN, 1 PCIe x4, 1 PCIe x1, 4 COM, 7 USB 3.0, 3 SIM, Isolated DIO
RCS-9430FH-GTX1080	RCS-9400F w/65W CPU, NVIDIA® GeForce® GTX1080, 2 GigE LAN, 1 PCIe x4, 1 PCIe x1, 4 COM, 7 USB 3.0, 3 SIM, Isolated DIO
RCS-9430FR-GTX1080	RCS-9400F, NVIDIA® GeForce® GTX1080, 2 GigE LAN, 1 PCIe x4, 1 PCIe x1, 4 Front-access SSD Tray, 4 COM, 7 USB 3.0, 3 SIM, Isolated DIO
RCS-9430FHR-GTX1080	RCS-9400F w/65W CPU, NVIDIA® GeForce® GTX1080, 2 GigE LAN, 1 PCIe x4, 1 PCIe x1, 4 Front-access SSD Tray, 4 COM, 7 USB 3.0, 3 SIM, Isolated DIO
RCS-9421F-GTX1080	RCS-9400F, NVIDIA® GeForce® GTX1080, 2 GigE LAN, 1 PCIe x4, 1 PCI, 4 COM, 7 USB 3.0, 3 SIM, Isolated DIO
RCS-9421FH-GTX1080	RCS-9400F w/65W CPU, NVIDIA® GeForce® GTX1080, 2 GigE LAN, 1 PCIe x4, 1 PCI, 4 COM, 7 USB 3.0, 3 SIM, Isolated DIO
RCS-9421FR-GTX1080	RCS-9400F, NVIDIA® GeForce® GTX1080, 2 GigE LAN, 1 PCIe x4, 1 PCI, 4 Front-access SSD Tray, 4 COM, 7 USB 3.0, 3 SIM, Isolated DIO
RCS-9421FHR-GTX1080	RCS-9400F w/65W CPU, NVIDIA® GeForce® GTX1080, 2 GigE LAN, 1 PCIe x4, 1 PCI, 4 Front-access SSD Tray, 4 COM, 7 USB 3.0, 3 SIM, Isolated DIO
RCS-9412F-GTX1080	RCS-9400F, NVIDIA® GeForce® GTX1080, 2 GigE LAN, 2 PCI, 4 COM, 7 USB 3.0, 3 SIM, Isolated DIO
RCS-9412FH-GTX1080	RCS-9400F w/65W CPU, NVIDIA® GeForce® GTX1080, 2 GigE LAN, 2 PCI, 4 COM, 7 USB 3.0, 3 SIM, Isolated DIO
RCS-9412FR-GTX1080	RCS-9400F, NVIDIA® GeForce® GTX1080, 2 GigE LAN, 2 PCI, 4 Front-access SSD Tray, 4 COM, 7 USB 3.0, 3 SIM, Isolated DIO
RCS-9412FHR-GTX1080	RCS-9400F w/65W CPU, NVIDIA® GeForce® GTX1080, 2 GigE LAN, 2 PCI, 4 Front-access SSD Tray, 4 COM, 7 USB 3.0, 3 SIM, Isolated DIO

Order Accessories

Part Number	Description
E3-1275 v6	Intel® Xeon® E3-1275 v6 Processor, 8M Cache, up to 4.20 GHz, 73W
E3-1275 v5	Intel® Xeon® E3-1275 v5 Processor, 8M Cache, up to 4.00 GHz, 80W
E3-1225 v5	Intel® Xeon® E3-1225 v5 Processor, 8M Cache, up to 3.70 GHz, 80W
E3-1268L v5	Intel® Xeon® E3-1268L v5 Processor, 8M Cache, up to 3.40 GHz, 35W
i7-7700	Intel® Core™ i7-7700 Processor, 8M Cache, up to 4.20 GHz, 65W
i7-7700T	Intel® Core™ i7-7700T Processor, 8M Cache, up to 3.80 GHz, 35W
i7-6700	Intel® Core™ i7-6700 Processor, 8M Cache, up to 4.00 GHz, 65W
i7-6700TE	Intel® Core™ i7-6700TE Processor, 8M Cache, up to 3.40 GHz, 35W
DDR4 16G	Certified DDR4 16GB 2133MHz RAM
DDR4 8G	Certified DDR4 8GB 2133MHz RAM
DDR4 4G	Certified DDR4 4GB 2133MHz RAM
PWA-280W-WT	280W, 24V, 85V AC to 264V AC Power Adapter with 3-pin Terminal Block, Wide Temperature -30°C to +70°C
PWS-360W	360W, 28.8V, 90V to 132V AC/180V to 264V AC Power Supply
PWS-480W-WT	480W, 24V, 90V AC to 305V AC Power Supply, Wide-Temp, IP65
PWS-600W	600W, 24V, 90V AC to 305V AC Power Supply
PWS-600W-WT	600W, 28.8V, 90V AC to 305V AC Power Supply, Wide Temperature -40°C to +70°C
TMK2-20P-100	Terminal Block 20-pin to Terminal Block 20-pin Cable, 100cm
TMK2-20P-500	Terminal Block 20-pin to Terminal Block 20-pin Cable, 500cm
TMB-TMBK-20P	Terminal Board with One 20-pin Terminal Block Connector and DIN-Rail Mounting
4G Module	Mini PCIe 4G/GPS Module with Antenna
WiFi & Bluetooth	Mini PCIe WiFi & Bluetooth Module with Antenna

Table of Contents

CHAPTER 1	GENERAL INTRODUCTION	1
1.1	Overview	1
1.2	Features	2
1.3	Product Specification	2
1.3.1	Specifications of RCS-9430F GTX1080	2
1.3.2	Specifications of RCS-9430FH GTX1080	5
1.3.3	Specifications of RCS-9430FR GTX1080	7
1.3.4	Specifications of RCS-9430FHR GTX1080	9
1.3.5	Specifications of RCS-9421F GTX1080	11
1.3.6	Specifications of RCS-9421FH	13
1.3.7	Specifications of RCS-9421FR GTX1080	15
1.3.8	Specifications of RCS-9421FHR GTX1080	17
1.3.9	Specifications of RCS-9412F GTX1080	19
1.3.10	Specifications of RCS-9412FH GTX1080	21
1.3.11	Specifications of RCS-9412FR GTX1080	23
1.3.12	Specifications of RCS-9412FHR GTX1080	25
1.4	Supported CPU List	27
1.5	Mechanical Dimension	28
1.5.1	Dimensions of RCS-9430F GTX1080/RCS-9421F GTX1080/ RCS-9412F GTX1080	28
1.5.2	Dimensions of RCS-9430FH GTX1080/RCS-9421FH GTX1080/ RCS-9412FH GTX1080	28
1.5.3	Dimensions of RCS-9430FR GTX1080/RCS-9421FR GTX1080/ RCS-9412FR GTX1080	29
1.5.4	Dimensions of RCS-9430FHR GTX1080/RCS-9421FHR GTX1080/ RCS-9412FHR GTX1080	29

CHAPTER 2	GETTING TO KNOW YOUR RCS-9000F GTX1080	30
2.1	Packing List	30
2.2	Front Panel I/O & Functions	31
2.3	Main Board Expansion Connectors	42
2.4	Main Board Jumper Settings	58
2.5	Ignition Control	62
CHAPTER 3	SYSTEM SETUP	65
3.1	How to Open Your RCS-9000F GTX1080	65
3.2	Installing CPU	75
3.3	Installing DDR4 SO-DIMM Modules	77
3.4	Installing Mini PCIe Card	78
3.5	Installing Antenna Cable	79
3.6	Installing CFast Card	81
3.7	Installing SIM Card	82
3.8	Installing PCI/PCIe Card	84
3.9	Installing SSD/HDD	85
3.10	Mounting Your RCS-9000F GTX1080	88
CHAPTER 4	BIOS AND DRIVER SETTING	89
4.1	BIOS Settings	89
4.2	Main Menu	90
4.3	Advanced Function	90
4.4	Chipset Functions	101
4.5	Security	106
4.6	Boot	108
4.7	Save & Exit	109

APPENDIX A: Isolated DIO Guide	110
APPENDIX B: GPIO and WDT Functions	115
APPENDIX C: RAID Installation Guide	116
APPENDIX D: Power Consumption	122
APPENDIX E : Supported Memory & Storage List	125
APPENDIX F : Power Supply Installation	128

1

GENERAL INTRODUCTION

1.1 Overview

RCS-9000F GTX1080 is a performance-driven expandable GPU Computing System for AI-oriented embedded applications. Powered by 7th Generation Intel® Xeon®/Core™ i7/i5/i3 processor, 2560 CUDA® cores NVIDIA® GeForce® GTX 1080 supporting advanced NVIDIA® Pascal™ architecture and up to 400% GPU computing performance, max 8K resolution and 7 independent HD displays, Vecow RCS-9000F GTX1080 boost up to 49% system performance enhancement and 1637% GPU performance improved than the platform without additional graphics engine; PCIe 3.0 (8GT/s), Multiple SATA III (6Gbps), USB 3.0 (5Gbps), PoE (1Gbps) LAN and wireless connections make high-speed data computing and conveying possible. Vecow RCS-9000F GTX1080 GPU computing system delivers leading system performance for demanding workloads.

Multiple DVI, DisplayPort and HDMI display interfaces supporting up to 7 HD displays, 2 independent Intel® GigE LAN supports iAMT 11.0, 4 external/internal 2.5" SSD/HDD support up to 32TB capacity with RAID 0, 1, 5, 10 data protection, 3 SIM card sockets for WiFi/4G/3G/LTE/GPRS/UMTS, 2 PCI/PCIe expansion, 7 USB 3.0, 2 USB 2.0, 1 internal CFast socket, 4 COM RS-232/422/485, 32 Isolated DIO, 3 Mini PCIe sockets, 10V to 36V wide range power input with 80V surge protection, configurable ignition power control, remote power switch, -25°C to 60°C operating temperature, Vecow RCS-9000F GTX1080 GPU Computing System integrates leading performance, flexible expansion, user-friendly, intelligent power protection functions, smart manageability, mobile availability and trusted reliability for any embedded applications.

With leading system performance, flexible integrated features, smart manageability, excellent mobile availability, intelligent power protection and industrial-grade reliability, Vecow RCS-9000F GTX1080 GPU Computing System is your great choices for Machine Vision, Deep Learning, Robotic Control, Autonomous Vehicles, Intelligent Automation, Machine Learning, and any artificial intelligence oriented industrial-grade AIoT applications.

1.2 Features

- LGA 1151 Socket supports workstation-grade 7th generation Intel® Xeon®/Core™ i7/i5/i3 Processor (Kaby Lake) with C236 Chipset
- 2560 CUDA® cores NVIDIA® GeForce® GTX 1080 supports NVIDIA® Pascal™ GPU architecture, up to 8K resolution
- Display : 3 DVI, 1 HDMI and 4 DisplayPort, up to 7 independent HD displays
- 2 DDR4 2133MHz Memory, up to 32GB (ECC/Non-ECC)
- 2 independent Gigabit LAN, iAMT 11.0 supported
- Storage : 4 2.5" SSD/HDD, 1 CFast Socket
- 3 SIM Card Socket for WiFi/4G/3G/LTE/GPRS/UMTS
- Expansion : 2 PCI/PCIe Slot, 3 Mini PCIe
- 7 USB 3.0, 4 COM, 4 SATA III
- 32 Isolated DIO : 16 DI, 16 DO
- 12V to 36V DC Power Input with 80V Surge Protection
- Configurable Ignition Power Control

1.3 Product Specification

1.3.1 Specifications of RCS-9430F GTX1080

System	
Processor	Quad Core Intel® Xeon®/Core™ i7/i5/i3 Processor (Kaby Lake-S/Skylake-S)
Chipset	Intel® C236
BIOS	AMI
SIO	IT8786E
Memory	<ul style="list-style-type: none">• DDR4 2133 MHz• Up to 32GB• 2 204-pin SO-DIMM Socket
I/O Interface	
Serial	4 COM RS-232/422/485 with auto flow control (ESD protection : Air gap ±15kV, Contact ±8kV)
USB	<ul style="list-style-type: none">• 7 USB 3.0 (6 External, 1 Internal)• 2 USB 2.0 (Internal)
Isolated DIO	32 Isolated DIO (16 DI, 16 DO)
LED	Power, HDD, Wireless
SIM Card	3 SIM Card Socket (2 External, 1 Internal)

Expansion	
Mini PCIe	3 Mini PCIe Socket : <ul style="list-style-type: none"> • 2 Full-size for PCIe/USB/External SIM Card • 1 Full-size for PCIe/USB/Internal SIM Card/mSATA
PCI/PCIe	<ul style="list-style-type: none"> • 1 PCIe x4 Slot • 1 PCIe x1 Slot
Graphics	
Graphics Processor	<ul style="list-style-type: none"> • Intel® HD Graphics 630/530 • NVIDIA® GeForce® GTX 1080
Interface	8 display interfaces : <ul style="list-style-type: none"> • 3 DVI : Up to 1920 x 1200 @ 60Hz • 3 DisplayPort : Up to 7680 x 3480 @ 60Hz • 1 DisplayPort : Up to 4096 x 2304 @ 60Hz • 1 HDMI : Up to 4096 x 2160 @ 60Hz
Storage	
SATA	4 SATA III (6Gbps) support software RAID 0, 1, 5, 10
mSATA	1 SATA III (Mini PCIe Type, 6Gbps)
Storage Device	<ul style="list-style-type: none"> • 1 CFast Socket (Internal) • 4 2.5" SSD/HDD Bracket (Internal)
Audio	
Audio Codec	Realtek ALC888S-VD, 7.1 Channel HD Audio
Audio Interface	1 Mic-in, 1 Line-out
Ethernet	
LAN 1	Intel® I219LM Gigabit LAN supports iAMT 11.0
LAN 2	Intel® I210 Gigabit LAN
Power	
Input Voltage	35W TDP CPU : 12V to 36V, DC-in 65W/80W TDP CPU : 16V to 36V, DC-in
Power Interface	3-pin Terminal Block : V+, V-, Frame Ground
Ignition Control	16 Mode (Internal)
Remote Switch	3-pin Terminal Block : On, Off, IGN
Surge Protection	Up to 80V/1ms Transient Power
Others	
TPM	Optional Infineon SLB9665 supports TPM 2.0, LPC interface
Watchdog Timer	Reset : 1 to 255 sec./min. per step
Smart Management	Wake on LAN, PXE supported
HW Monitor	Monitoring temperature, voltages. Auto throttling control when CPU overheats.

Software Support	
OS	Windows 10, Windows 8.1, Windows 7
Linux	Fedora 13, Ubuntu 10.04 LTS, or Linux Kernel 3.0 above
Mechanical	
Dimension (W x D x H)	172mm x 330mm x 210mm (6.8" x 13" x 8.3")
Weight	4.4 kg (9.7 lb)
Mounting	Wall mount by mounting bracket
Environment	
Operating Temperature	35W TDP CPU : <ul style="list-style-type: none"> • Intel® Xeon® E3 : -25°C to 60°C (-13°F to 140°F) • Intel® Core™ i7/i5/i3 : -25°C to 60°C (-13°F to 140°F) 65W TDP CPU : Intel® Core™ i7/i5/i3 : -25°C to 55°C (-13°F to 131°F) 80W TDP CPU : Intel® Xeon® E3 : -25°C to 45°C (-13°F to 113°F)
Storage Temperature	-40°C to 85°C (-40°F to 185°F)
Humidity	5% to 95% humidity, non-condensing
Relative Humidity	95% at 60°C
Shock	<ul style="list-style-type: none"> • IEC 60068-2-27 • SSD : 50G @ wallmount, Half-sine, 11ms
Vibration	<ul style="list-style-type: none"> • IEC 60068-2-64 • SSD : 5Grms, 5Hz to 500Hz, 3 Axis
EMC	CE, FCC, EN50155, EN50121-3-2

1.3.2 Specifications of RCS-9430FH GTX1080

System	
Processor	Quad Core Intel® Xeon®/Core™ i7/i5/i3 Processor (Kaby Lake-S/Skylake-S)
Chipset	Intel® C236
BIOS	AMI
SIO	IT8786E
Memory	<ul style="list-style-type: none"> • DDR4 2133MHz • Up to 32GB • 2 204-pin SO-DIMM Socket
I/O Interface	
Serial	4 COM RS-232/422/485 with auto flow control (ESD protection : Air gap ±15kV, Contact ±8kV)
USB	<ul style="list-style-type: none"> • 7 USB 3.0 (6 External, 1 Internal) • 2 USB 2.0 (Internal)
Isolated DIO	32 Isolated DIO (16 DI, 16 DO)
LED	Power, HDD, Wireless
SIM Card	3 SIM Card Socket (2 External, 1 Internal)
Expansion	
Mini PCIe	3 Mini PCIe Socket : <ul style="list-style-type: none"> • 2 Full-size for PCIe/USB/External SIM Card • 1 Full-size for PCIe/USB/Internal SIM Card/mSATA
PCI/PCIe	<ul style="list-style-type: none"> • 1 PCIe x4 Slot • 1 PCIe x1 Slot
Graphics	
Graphics Processor	<ul style="list-style-type: none"> • Intel® HD Graphics 630/530 • NVIDIA® GeForce® GTX 1080
Interface	8 display interfaces : <ul style="list-style-type: none"> • 3 DVI : Up to 1920 x 1200 @ 60Hz • 3 DisplayPort : Up to 7680 x 3480 @ 60Hz • 1 DisplayPort : Up to 4096 x 2304 @ 60Hz • 1 HDMI : Up to 4096 x 2160 @ 60Hz
Storage	
SATA	4 SATA III (6Gbps) support software RAID 0, 1, 5, 10
mSATA	1 SATA III (Mini PCIe Type, 6Gbps)
Storage Device	<ul style="list-style-type: none"> • 1 CFast Socket (Internal) • 4 2.5" SSD/HDD Bracket (Internal)
Audio	
Audio Codec	Realtek ALC888S-VD, 7.1 Channel HD Audio
Audio Interface	1 Mic-in, 1 Line-out

Ethernet	
LAN 1	Intel® I219LM Gigabit LAN supports iAMT 11.0
LAN 2	Intel® I210 Gigabit LAN
Power	
Input Voltage	35W TDP CPU : 12V to 36V, DC-in 65W/80W TDP CPU : 16V to 36V, DC-in
Power Interface	3-pin Terminal Block : V+, V-, Frame Ground
Ignition Control	16 Mode (Internal)
Remote Switch	3-pin Terminal Block : On, Off, IGN
Surge Protection	Up to 80V/1ms Transient Power
Others	
TPM	Optional Infineon SLB9665 supports TPM 2.0, LPC interface
Watchdog Timer	Reset : 1 to 255 sec./min. per step
Smart Management	Wake on LAN, PXE supported
HW Monitor	Monitoring temperature, voltages. Auto throttling control when CPU overheats.
Software Support	
Microsoft	Windows 10, Windows 8.1, Windows 7
Linux	Fedora 13, Ubuntu 10.04 LTS, or Linux Kernel 3.0 above
Mechanical	
Dimension (W x D x H)	172mm x 330mm x 210mm (6.8" x 13" x 8.3")
Weight	5.1 kg (11.2 lb)
Mounting	Wallmount by mounting bracket
Environment	
Operating Temperature	35W TDP CPU : <ul style="list-style-type: none"> • Intel® Xeon® E3 : -25°C to 60°C (-13°F to 140°F) • Intel® Core™ i7/i5/i3 : -25°C to 60°C (-13°F to 140°F) 65W TDP CPU : <ul style="list-style-type: none"> • Intel® Core™ i7/i5/i3 : -25°C to 55°C (-13°F to 131°F) 80W TDP CPU : <ul style="list-style-type: none"> • Intel® Xeon® E3 : -25°C to 45°C (-13°F to 113°F)
Storage Temperature	-40°C to 85°C (-40°F to 185°F)
Humidity	5% to 95% humidity, non-condensing
Relative Humidity	95% at 55°C
Shock	<ul style="list-style-type: none"> • IEC 60068-2-27 • SSD : 50G @ wallmount, Half-sine, 11ms
Vibration	<ul style="list-style-type: none"> • IEC 60068-2-64 • SSD : 5Grms, 5Hz to 500Hz, 3 Axis
EMC	CE, FCC, EN50155, EN50121-3-2

1.3.3 Specifications of RCS-9430FR GTX1080

System	
Processor	Quad Core Intel® Xeon®/Core™ i7/i5/i3 Processor (Kaby Lake-S/Skylake-S)
Chipset	Intel® C236
BIOS	AMI
SIO	IT8786E
Memory	<ul style="list-style-type: none"> • DDR4 2133MHz • Up to 32GB • 2 204-pin SO-DIMM Socket
I/O Interface	
Serial	4 COM RS-232/422/485 with auto flow control (ESD protection : Air gap ±15kV, Contact ±8kV)
USB	<ul style="list-style-type: none"> • 7 USB 3.0 (6 External, 1 Internal) • 2 USB 2.0 (Internal)
Isolated DIO	32 Isolated DIO (16 DI, 16 DO)
LED	Power, HDD, Wireless
SIM Card	3 SIM Card Socket (2 External, 1 Internal)
Expansion	
Mini PCIe	3 Mini PCIe Socket : <ul style="list-style-type: none"> • 2 Full-size for PCIe/USB/External SIM Card • 1 Full-size for PCIe/USB/Internal SIM Card/mSATA
PCI/PCIe	<ul style="list-style-type: none"> • 1 PCIe x4 Slot • 1 PCIe x1 Slot
Graphics	
Graphics Processor	<ul style="list-style-type: none"> • Intel® HD Graphics 630/530 • NVIDIA® GeForce® GTX 1080
Interface	8 display interfaces : <ul style="list-style-type: none"> • 3 DVI : Up to 1920 x 1200 @ 60Hz • 3 DisplayPort : Up to 7680 x 3480 @ 60Hz • 1 DisplayPort : Up to 4096 x 2304 @ 60Hz • 1 HDMI : Up to 4096 x 2160 @ 60Hz
Storage	
SATA	4 SATA III (6Gbps) support software RAID 0, 1, 5, 10
mSATA	1 SATA III (Mini PCIe Type, 6Gbps)
Storage Device	<ul style="list-style-type: none"> • 1 CFast Socket (Internal) • 4 2.5" SSD/HDD Tray
Audio	
Audio Codec	Realtek ALC888S-VD, 7.1 Channel HD Audio
Audio Interface	1 Mic-in, 1 Line-out

Ethernet	
LAN 1	Intel® I219LM Gigabit LAN supports iAMT 11.0
LAN 2	Intel® I210 Gigabit LAN
Power	
Input Voltage	35W TDP CPU : 12V to 36V, DC-in 65W/80W TDP CPU : 16V to 36V, DC-in
Power Interface	3-pin Terminal Block : V+, V-, Frame Ground
Ignition Control	16 Mode (Internal)
Remote Switch	3-pin Terminal Block : On, Off, IGN
Surge Protection	Up to 80V/1ms Transient Power
Others	
TPM	Optional Infineon SLB9665 supports TPM 2.0, LPC interface
Watchdog Timer	Reset : 1 to 255 sec./min. per step
Smart Management	Wake on LAN, PXE supported
HW Monitor	Monitoring temperature, voltages. Auto throttling control when CPU overheats.
Software Support	
Microsoft	Windows 10, Windows 8.1, Windows 7
Linux	Fedora 13, Ubuntu 10.04 LTS, or Linux Kernel 3.0 above
Mechanical	
Dimension (W x D x H)	172mm x 330mm x 210mm (6.8" x 13" x 8.3")
Weight	5.6 kg (12.3 lb)
Mounting	Wallmount by mounting bracket
Environment	
Operating Temperature	35W TDP CPU : <ul style="list-style-type: none"> • Intel® Xeon® E3 : -25°C to 60°C (-13°F to 140°F) • Intel® Core™ i7/i5/i3 : -25°C to 60°C (-13°F to 140°F) 65W TDP CPU : <ul style="list-style-type: none"> • Intel® Core™ i7/i5/i3 : -25°C to 55°C (-13°F to 131°F) 80W TDP CPU : <ul style="list-style-type: none"> • Intel® Xeon® E3 : -25°C to 45°C (-13°F to 113°F)
Storage Temperature	-40°C to 85°C (-40°F to 185°F)
Humidity	5% to 95% humidity, non-condensing
Relative Humidity	95% at 60°C
Shock	<ul style="list-style-type: none"> • IEC 60068-2-27 • SSD : 50G @ wallmount, Half-sine, 11ms
Vibration	<ul style="list-style-type: none"> • IEC 60068-2-64 • SSD : 5Grms, 5Hz to 500Hz, 3 Axis
EMC	CE, FCC, EN50155, EN50121-3-2

1.3.4 Specifications of RCS-9430FHR GTX1080

System	
Processor	Quad Core Intel® Xeon®/Core™ i7/i5/i3 Processor (Kaby Lake-S/Skylake-S)
Chipset	Intel® C236
BIOS	AMI
SIO	IT8786E
Memory	<ul style="list-style-type: none"> • DDR4 2133MHz • Up to 32GB • 2 204-pin SO-DIMM Socket
I/O Interface	
Serial	4 COM RS-232/422/485 with auto flow control (ESD protection : Air gap ±15kV, Contact ±8kV)
USB	<ul style="list-style-type: none"> • 7 USB 3.0 (6 External, 1 Internal) • 2 USB 2.0 (Internal)
Isolated DIO	32 Isolated DIO (16 DI, 16 DO)
LED	Power, HDD, Wireless
SIM Card	3 SIM Card Socket (2 External, 1 Internal)
Expansion	
Mini PCIe	3 Mini PCIe Socket : <ul style="list-style-type: none"> • 2 Full-size for PCIe/USB/External SIM Card • 1 Full-size for PCIe/USB/Internal SIM Card/mSATA
PCI/PCIe	<ul style="list-style-type: none"> • 1 PCIe x4 Slot • 1 PCIe x1 Slot
Graphics	
Graphics Processor	<ul style="list-style-type: none"> • Intel® HD Graphics 630/530 • NVIDIA® GeForce® GTX 1080
Interface	8 display interfaces : <ul style="list-style-type: none"> • 3 DVI : Up to 1920 x 1200 @ 60Hz • 3 DisplayPort : Up to 7680 x 3480 @ 60Hz • 1 DisplayPort : Up to 4096 x 2304 @ 60Hz • 1 HDMI : Up to 4096 x 2160 @ 60Hz
Storage	
SATA	4 SATA III (6Gbps) support software RAID 0, 1, 5, 10
mSATA	1 SATA III (Mini PCIe Type, 6Gbps)
Storage Device	<ul style="list-style-type: none"> • 1 CFast Socket (Internal) • 4 2.5" SSD/HDD Tray
Audio	
Audio Codec	Realtek ALC888S-VD, 7.1 Channel HD Audio
Audio Interface	1 Mic-in, 1 Line-out

Ethernet	
LAN 1	Intel® I219LM Gigabit LAN supports iAMT 11.0
LAN 2	Intel® I210 Gigabit LAN
Power	
Input Voltage	35W TDP CPU : 12V to 36V, DC-in 65W/80W TDP CPU : 16V to 36V, DC-in
Power Interface	3-pin Terminal Block : V+, V-, Frame Ground
Ignition Control	16 Mode (Internal)
Remote Switch	3-pin Terminal Block : On, Off, IGN
Surge Protection	Up to 80V/1ms Transient Power
Others	
TPM	Optional Infineon SLB9665 supports TPM 2.0, LPC interface
Watchdog Timer	Reset : 1 to 255 sec./min. per step
Smart Management	Wake on LAN, PXE supported
HW Monitor	Monitoring temperature, voltages. Auto throttling control when CPU overheats.
Software Support	
Microsoft	Windows 10, Windows 8.1, Windows 7
Linux	Fedora 13, Ubuntu 10.04 LTS, or Linux Kernel 3.0 above
Mechanical	
Dimension (W x D x H)	172mm x 330mm x 210mm (6.8" x 13" x 8.3")
Weight	6.3 kg (13.9 lb)
Mounting	Wallmount by mounting bracket
Environment	
Operating Temperature	35W TDP CPU : <ul style="list-style-type: none"> • Intel® Xeon® E3 : -25°C to 60°C (-13°F to 140°F) • Intel® Core™ i7/i5/i3 : -25°C to 60°C (-13°F to 140°F) 65W TDP CPU : <ul style="list-style-type: none"> • Intel® Core™ i7/i5/i3 : -25°C to 55°C (-13°F to 131°F) 80W TDP CPU : <ul style="list-style-type: none"> • Intel® Xeon® E3 : -25°C to 45°C (-13°F to 113°F)
Storage Temperature	-40°C to 85°C (-40°F to 185°F)
Humidity	5% to 95% humidity, non-condensing
Relative Humidity	95% at 55°C
Shock	<ul style="list-style-type: none"> • IEC 60068-2-27 • SSD : 50G @ wallmount, Half-sine, 11ms
Vibration	<ul style="list-style-type: none"> • IEC 60068-2-64 • SSD : 5Grms, 5Hz to 500Hz, 3 Axis
EMC	CE, FCC, EN50155, EN50121-3-2

1.3.5 Specifications of RCS-9421F GTX1080

System	
Processor	Quad Core Intel® Xeon®/Core™ i7/i5/i3 Processor (Kaby Lake-S/Skylake-S)
Chipset	Intel® C236
BIOS	AMI
SIO	IT8786E
Memory	<ul style="list-style-type: none"> • DDR4 2133MHz • Up to 32GB • 2 204-pin SO-DIMM Socket
I/O Interface	
Serial	4 COM RS-232/422/485 with auto flow control (ESD protection : Air gap ±15kV, Contact ±8kV)
USB	<ul style="list-style-type: none"> • 7 USB 3.0 (6 External, 1 Internal) • 2 USB 2.0 (Internal)
Isolated DIO	32 Isolated DIO (16 DI, 16 DO)
LED	Power, HDD, Wireless
SIM Card	3 SIM Card Socket (2 External, 1 Internal)
Expansion	
Mini PCIe	3 Mini PCIe Socket : <ul style="list-style-type: none"> • 2 Full-size for PCIe/USB/External SIM Card • 1 Full-size for PCIe/USB/Internal SIM Card/mSATA
PCI/PCIe	<ul style="list-style-type: none"> • 1 PCIe x4 Slot • 1 PCI Slot
Graphics	
Graphics Processor	<ul style="list-style-type: none"> • Intel® HD Graphics 630/530 • NVIDIA® GeForce® GTX 1080
Interface	8 display interfaces : <ul style="list-style-type: none"> • 3 DVI : Up to 1920 x 1200 @ 60Hz • 3 DisplayPort : Up to 7680 x 3480 @ 60Hz • 1 DisplayPort : Up to 4096 x 2304 @ 60Hz • 1 HDMI : Up to 4096 x 2160 @ 60Hz
Storage	
SATA	4 SATA III (6Gbps) support software RAID 0, 1, 5, 10
mSATA	1 SATA III (Mini PCIe Type, 6Gbps)
Storage Device	<ul style="list-style-type: none"> • 1 CFast Socket (Internal) • 4 2.5" SSD/HDD Bracket (Internal)
Audio	
Audio Codec	Realtek ALC888S-VD, 7.1 Channel HD Audio
Audio Interface	1 Mic-in, 1 Line-out

Ethernet	
LAN 1	Intel® I219LM Gigabit LAN supports iAMT 11.0
LAN 2	Intel® I210 Gigabit LAN
Power	
Input Voltage	35W TDP CPU : 12V to 36V, DC-in 65W/80W TDP CPU : 16V to 36V, DC-in
Power Interface	3-pin Terminal Block : V+, V-, Frame Ground
Ignition Control	16 Mode (Internal)
Remote Switch	3-pin Terminal Block : On, Off, IGN
Surge Protection	Up to 80V/1ms Transient Power
Others	
TPM	Optional Infineon SLB9665 supports TPM 2.0, LPC interface
Watchdog Timer	Reset : 1 to 255 sec./min. per step
Smart Management	Wake on LAN, PXE supported
HW Monitor	Monitoring temperature, voltages. Auto throttling control when CPU overheats.
Software Support	
Microsoft	Windows 10, Windows 8.1, Windows 7
Linux	Fedora 13, Ubuntu 10.04 LTS, or Linux Kernel 3.0 above
Mechanical	
Dimension (W x D x H)	172mm x 330mm x 210mm (6.8" x 13" x 8.3")
Weight	4.4 kg (9.7 lb)
Mounting	Wallmount by mounting bracket
Environment	
Operating Temperature	35W TDP CPU : <ul style="list-style-type: none"> • Intel® Xeon® E3 : -25°C to 60°C (-13°F to 140°F) • Intel® Core™ i7/i5/i3 : -25°C to 60°C (-13°F to 140°F) 65W TDP CPU : <ul style="list-style-type: none"> • Intel® Core™ i7/i5/i3 : -25°C to 55°C (-13°F to 131°F) 80W TDP CPU : <ul style="list-style-type: none"> • Intel® Xeon® E3 : -25°C to 45°C (-13°F to 113°F)
Storage Temperature	-40°C to 85°C (-40°F to 185°F)
Humidity	5% to 95% humidity, non-condensing
Relative Humidity	95% at 60°C
Shock	<ul style="list-style-type: none"> • IEC 60068-2-27 • SSD : 50G @ wallmount, Half-sine, 11ms
Vibration	<ul style="list-style-type: none"> • IEC 60068-2-64 • SSD : 5Grms, 5Hz to 500Hz, 3 Axis
EMC	CE, FCC, EN50155, EN50121-3-2

1.3.6 Specifications of RCS-9421FH

System	
Processor	Quad Core Intel® Xeon®/Core™ i7/i5/i3 Processor (Kaby Lake-S/Skylake-S)
Chipset	Intel® C236
BIOS	AMI
SIO	IT8786E
Memory	<ul style="list-style-type: none"> • DDR4 2133MHz • Up to 32GB • 2 204-pin SO-DIMM Socket
I/O Interface	
Serial	4 COM RS-232/422/485 with auto flow control (ESD protection : Air gap ±15kV, Contact ±8kV)
USB	<ul style="list-style-type: none"> • 7 USB 3.0 (6 External, 1 Internal) • 2 USB 2.0 (Internal)
Isolated DIO	32 Isolated DIO (16 DI, 16 DO)
LED	Power, HDD, Wireless
SIM Card	3 SIM Card Socket (2 External, 1 Internal)
Expansion	
Mini PCIe	3 Mini PCIe Socket : <ul style="list-style-type: none"> • 2 Full-size for PCIe/USB/External SIM Card • 1 Full-size for PCIe/USB/Internal SIM Card/mSATA
PCI/PCIe	<ul style="list-style-type: none"> • 1 PCIe x4 Slot • 1 PCI Slot
Graphics	
Graphics Processor	<ul style="list-style-type: none"> • Intel® HD Graphics 630/530 • NVIDIA® GeForce® GTX 1080
Interface	8 display interfaces : <ul style="list-style-type: none"> • 3 DVI : Up to 1920 x 1200 @ 60Hz • 3 DisplayPort : Up to 7680 x 3480 @ 60Hz • 1 DisplayPort : Up to 4096 x 2304 @ 60Hz • 1 HDMI : Up to 4096 x 2160 @ 60Hz
Storage	
SATA	4 SATA III (6Gbps) support software RAID 0, 1, 5, 10
mSATA	1 SATA III (Mini PCIe Type, 6Gbps)
Storage Device	<ul style="list-style-type: none"> • 1 CFast Socket (Internal) • 4 2.5" SSD/HDD Bracket (Internal)
Audio	
Audio Codec	Realtek ALC888S-VD, 7.1 Channel HD Audio
Audio Interface	1 Mic-in, 1 Line-out

Ethernet	
LAN 1	Intel® I219LM Gigabit LAN supports iAMT 11.0
LAN 2	Intel® I210 Gigabit LAN
Power	
Input Voltage	35W TDP CPU : 12V to 36V, DC-in 65W/80W TDP CPU : 16V to 36V, DC-in
Power Interface	3-pin Terminal Block : V+, V-, Frame Ground
Ignition Control	16 Mode (Internal)
Remote Switch	3-pin Terminal Block : On, Off, IGN
Surge Protection	Up to 80V/1ms Transient Power
Others	
TPM	Optional Infineon SLB9665 supports TPM 2.0, LPC interface
Watchdog Timer	Reset : 1 to 255 sec./min. per step
Smart Management	Wake on LAN, PXE supported
HW Monitor	Monitoring temperature, voltages. Auto throttling control when CPU overheats.
Software Support	
Microsoft	Windows 10, Windows 8.1, Windows 7
Linux	Fedora 13, Ubuntu 10.04 LTS, or Linux Kernel 3.0 above
Mechanical	
Dimension (W x D x H)	172mm x 330mm x 210mm (6.8" x 13" x 8.3")
Weight	5.1 kg (11.2 lb)
Mounting	Wallmount by mounting bracket
Environment	
Operating Temperature	35W TDP CPU : <ul style="list-style-type: none"> • Intel® Xeon® E3 : -25°C to 60°C (-13°F to 140°F) • Intel® Core™ i7/i5/i3 : -25°C to 60°C (-13°F to 140°F) 65W TDP CPU : <ul style="list-style-type: none"> • Intel® Core™ i7/i5/i3 : -25°C to 55°C (-13°F to 131°F) 80W TDP CPU : <ul style="list-style-type: none"> • Intel® Xeon® E3 : -25°C to 45°C (-13°F to 113°F)
Storage Temperature	-40°C to 85°C (-40°F to 185°F)
Humidity	5% to 95% humidity, non-condensing
Relative Humidity	95% at 55°C
Shock	<ul style="list-style-type: none"> • IEC 60068-2-27 • SSD : 50G @ wallmount, Half-sine, 11ms
Vibration	<ul style="list-style-type: none"> • IEC 60068-2-64 • SSD : 5Grms, 5Hz to 500Hz, 3 Axis
EMC	CE, FCC, EN50155, EN50121-3-2

1.3.7 Specifications of RCS-9421FR GTX1080

System	
Processor	Quad Core Intel® Xeon®/Core™ i7/i5/i3 Processor (Kaby Lake-S/Skylake-S)
Chipset	Intel® C236
BIOS	AMI
SIO	IT8786E
Memory	<ul style="list-style-type: none"> • DDR4 2133MHz • Up to 32GB • 2 204-pin SO-DIMM Socket
I/O Interface	
Serial	4 COM RS-232/422/485 with auto flow control (ESD protection : Air gap ±15kV, Contact ±8kV)
USB	<ul style="list-style-type: none"> • 7 USB 3.0 (6 External, 1 Internal) • 2 USB 2.0 (Internal)
Isolated DIO	32 Isolated DIO (16 DI, 16 DO)
LED	Power, HDD, Wireless
SIM Card	3 SIM Card Socket (2 External, 1 Internal)
Expansion	
Mini PCIe	3 Mini PCIe Socket : <ul style="list-style-type: none"> • 2 Full-size for PCIe/USB/External SIM Card • 1 Full-size for PCIe/USB/Internal SIM Card/mSATA
PCI/PCIe	<ul style="list-style-type: none"> • 1 PCIe x4 Slot • 1 PCI Slot
Graphics	
Graphics Processor	<ul style="list-style-type: none"> • Intel® HD Graphics 630/530 • NVIDIA® GeForce® GTX 1080
Interface	8 display interfaces : <ul style="list-style-type: none"> • 3 DVI : Up to 1920 x 1200 @ 60Hz • 3 DisplayPort : Up to 7680 x 3480 @ 60Hz • 1 DisplayPort : Up to 4096 x 2304 @ 60Hz • 1 HDMI : Up to 4096 x 2160 @ 60Hz
Storage	
SATA	4 SATA III (6Gbps) support software RAID 0, 1, 5, 10
mSATA	1 SATA III (Mini PCIe Type, 6Gbps)
Storage Device	<ul style="list-style-type: none"> • 1 CFast Socket (Internal) • 4 2.5" SSD/HDD Tray
Audio	
Audio Codec	Realtek ALC888S-VD, 7.1 Channel HD Audio
Audio Interface	1 Mic-in, 1 Line-out

Ethernet	
LAN 1	Intel® I219LM Gigabit LAN supports iAMT 11.0
LAN 2	Intel® I210 Gigabit LAN
Power	
Input Voltage	35W TDP CPU : 12V to 36V, DC-in 65W/80W TDP CPU : 16V to 36V, DC-in
Power Interface	3-pin Terminal Block : V+, V-, Frame Ground
Ignition Control	16 Mode (Internal)
Remote Switch	3-pin Terminal Block : On, Off, IGN
Surge Protection	Up to 80V/1ms Transient Power
Others	
TPM	Optional Infineon SLB9665 supports TPM 2.0, LPC interface
Watchdog Timer	Reset : 1 to 255 sec./min. per step
Smart Management	Wake on LAN, PXE supported
HW Monitor	Monitoring temperature, voltages. Auto throttling control when CPU overheats.
Software Support	
Microsoft	Windows 10, Windows 8.1, Windows 7
Linux	Fedora 13, Ubuntu 10.04 LTS, or Linux Kernel 3.0 above
Mechanical	
Dimension (W x D x H)	172mm x 330mm x 210mm (6.8" x 13" x 8.3")
Weight	5.6 kg (12.3 lb)
Mounting	Wallmount by mounting bracket
Environment	
Operating Temperature	35W TDP CPU : <ul style="list-style-type: none"> • Intel® Xeon® E3 : -25°C to 60°C (-13°F to 140°F) • Intel® Core™ i7/i5/i3 : -25°C to 60°C (-13°F to 140°F) 65W TDP CPU : <ul style="list-style-type: none"> • Intel® Core™ i7/i5/i3 : -25°C to 55°C (-13°F to 131°F) 80W TDP CPU : <ul style="list-style-type: none"> • Intel® Xeon® E3 : -25°C to 45°C (-13°F to 113°F)
Storage Temperature	-40°C to 85°C (-40°F to 185°F)
Humidity	5% to 95% humidity, non-condensing
Relative Humidity	95% at 60°C
Shock	<ul style="list-style-type: none"> • IEC 60068-2-27 • SSD : 50G @ wallmount, Half-sine, 11ms
Vibration	<ul style="list-style-type: none"> • IEC 60068-2-64 • SSD : 5Grms, 5Hz to 500Hz, 3 Axis
EMC	CE, FCC, EN50155, EN50121-3-2

1.3.8 Specifications of RCS-9421FHR GTX1080

System	
Processor	Quad Core Intel® Xeon®/Core™ i7/i5/i3 Processor (Kaby Lake-S/Skylake-S)
Chipset	Intel® C236
BIOS	AMI
SIO	IT8786E
Memory	<ul style="list-style-type: none"> • DDR4 2133MHz • Up to 32GB • 2 204-pin SO-DIMM Socket
I/O Interface	
Serial	4 COM RS-232/422/485 with auto flow control (ESD protection : Air gap ±15kV, Contact ±8kV)
USB	<ul style="list-style-type: none"> • 7 USB 3.0 (6 External, 1 Internal) • 2 USB 2.0 (Internal)
Isolated DIO	32 Isolated DIO (16 DI, 16 DO)
LED	Power, HDD, Wireless
SIM Card	3 SIM Card Socket (2 External, 1 Internal)
Expansion	
Mini PCIe	3 Mini PCIe Socket : <ul style="list-style-type: none"> • 2 Full-size for PCIe/USB/External SIM Card • 1 Full-size for PCIe/USB/Internal SIM Card/mSATA
PCI/PCIe	<ul style="list-style-type: none"> • 1 PCIe x4 Slot • 1 PCI Slot
Graphics	
Graphics Processor	<ul style="list-style-type: none"> • Intel® HD Graphics 630/530 • NVIDIA® GeForce® GTX 1080
Interface	8 display interfaces : <ul style="list-style-type: none"> • 3 DVI : Up to 1920 x 1200 @ 60Hz • 3 DisplayPort : Up to 7680 x 3480 @ 60Hz • 1 DisplayPort : Up to 4096 x 2304 @ 60Hz • 1 HDMI : Up to 4096 x 2160 @ 60Hz
Storage	
SATA	4 SATA III (6Gbps) support software RAID 0, 1, 5, 10
mSATA	1 SATA III (Mini PCIe Type, 6Gbps)
Storage Device	<ul style="list-style-type: none"> • 1 CFast Socket (Internal) • 4 2.5" SSD/HDD Tray
Audio	
Audio Codec	Realtek ALC888S-VD, 7.1 Channel HD Audio
Audio Interface	1 Mic-in, 1 Line-out

Ethernet	
LAN 1	Intel® I219LM Gigabit LAN supports iAMT 11.0
LAN 2	Intel® I210 Gigabit LAN
Power	
Input Voltage	35W TDP CPU : 12V to 36V, DC-in 65W/80W TDP CPU : 16V to 36V, DC-in
Power Interface	3-pin Terminal Block : V+, V-, Frame Ground
Ignition Control	16 Mode (Internal)
Remote Switch	3-pin Terminal Block : On, Off, IGN
Surge Protection	Up to 80V/1ms Transient Power
Others	
TPM	Optional Infineon SLB9665 supports TPM 2.0, LPC interface
Watchdog Timer	Reset : 1 to 255 sec./min. per step
Smart Management	Wake on LAN, PXE supported
HW Monitor	Monitoring temperature, voltages. Auto throttling control when CPU overheats.
Software Support	
Microsoft	Windows 10, Windows 8.1, Windows 7
Linux	Fedora 13, Ubuntu 10.04 LTS, or Linux Kernel 3.0 above
Mechanical	
Dimension (W x D x H)	172mm x 330mm x 210mm (6.8" x 13" x 8.3")
Weight	6.3 kg (13.9 lb)
Mounting	Wallmount by mounting bracket
Environment	
Operating Temperature	35W TDP CPU : <ul style="list-style-type: none"> • Intel® Xeon® E3 : -25°C to 60°C (-13°F to 140°F) • Intel® Core™ i7/i5/i3 : -25°C to 60°C (-13°F to 140°F) 65W TDP CPU : <ul style="list-style-type: none"> • Intel® Core™ i7/i5/i3 : -25°C to 55°C (-13°F to 131°F) 80W TDP CPU : <ul style="list-style-type: none"> • Intel® Xeon® E3 : -25°C to 45°C (-13°F to 113°F)
Storage Temperature	-40°C to 85°C (-40°F to 185°F)
Humidity	5% to 95% humidity, non-condensing
Relative Humidity	95% at 55°C
Shock	<ul style="list-style-type: none"> • IEC 60068-2-27 • SSD : 50G @ wallmount, Half-sine, 11ms
Vibration	<ul style="list-style-type: none"> • IEC 60068-2-64 • SSD : 5Grms, 5Hz to 500Hz, 3 Axis
EMC	CE, FCC, EN50155, EN50121-3-2

1.3.9 Specifications of RCS-9412F GTX1080

System	
Processor	Quad Core Intel® Xeon®/Core™ i7/i5/i3 Processor (Kaby Lake-S/Skylake-S)
Chipset	Intel® C236
BIOS	AMI
SIO	IT8786E
Memory	<ul style="list-style-type: none"> • DDR4 2133MHz • Up to 32GB • 2 204-pin SO-DIMM Socket
I/O Interface	
Serial	4 COM RS-232/422/485 with auto flow control (ESD protection : Air gap ±15kV, Contact ±8kV)
USB	<ul style="list-style-type: none"> • 7 USB 3.0 (6 External, 1 Internal) • 2 USB 2.0 (Internal)
Isolated DIO	32 Isolated DIO (16 DI, 16 DO)
LED	Power, HDD, Wireless
SIM Card	3 SIM Card Socket (2 External, 1 Internal)
Expansion	
Mini PCIe	3 Mini PCIe Socket : <ul style="list-style-type: none"> • 2 Full-size for PCIe/USB/External SIM Card • 1 Full-size for PCIe/USB/Internal SIM Card/mSATA
PCI/PCIe	<ul style="list-style-type: none"> • 2 PCI Slot
Graphics	
Graphics Processor	<ul style="list-style-type: none"> • Intel® HD Graphics 630/530 • NVIDIA® GeForce® GTX 1080
Interface	8 display interfaces : <ul style="list-style-type: none"> • 3 DVI : Up to 1920 x 1200 @ 60Hz • 3 DisplayPort : Up to 7680 x 3480 @ 60Hz • 1 DisplayPort : Up to 4096 x 2304 @ 60Hz • 1 HDMI : Up to 4096 x 2160 @ 60Hz
Storage	
SATA	4 SATA III (6Gbps) support software RAID 0, 1, 5, 10
mSATA	1 SATA III (Mini PCIe Type, 6Gbps)
Storage Device	<ul style="list-style-type: none"> • 1 CFast Socket (Internal) • 4 2.5" SSD/HDD Bracket (Internal)
Audio	
Audio Codec	Realtek ALC888S-VD, 7.1 Channel HD Audio
Audio Interface	1 Mic-in, 1 Line-out

Ethernet	
LAN 1	Intel® I219LM Gigabit LAN supports iAMT 11.0
LAN 2	Intel® I210 Gigabit LAN
Power	
Input Voltage	35W TDP CPU : 12V to 36V, DC-in 65W/80W TDP CPU : 16V to 36V, DC-in
Power Interface	3-pin Terminal Block : V+, V-, Frame Ground
Ignition Control	16 Mode (Internal)
Remote Switch	3-pin Terminal Block : On, Off, IGN
Surge Protection	Up to 80V/1ms Transient Power
Others	
TPM	Optional Infineon SLB9665 supports TPM 2.0, LPC interface
Watchdog Timer	Reset : 1 to 255 sec./min. per step
Smart Management	Wake on LAN, PXE supported
HW Monitor	Monitoring temperature, voltages. Auto throttling control when CPU overheats.
Software Support	
Microsoft	Windows 10, Windows 8.1, Windows 7
Linux	Fedora 13, Ubuntu 10.04 LTS, or Linux Kernel 3.0 above
Mechanical	
Dimension (W x D x H)	172mm x 330mm x 210mm (6.8" x 13" x 8.3")
Weight	4.4 kg (9.7 lb)
Mounting	Wallmount by mounting bracket
Environment	
Operating Temperature	35W TDP CPU : <ul style="list-style-type: none"> • Intel® Xeon® E3 : -25°C to 60°C (-13°F to 140°F) • Intel® Core™ i7/i5/i3 : -25°C to 60°C (-13°F to 140°F) 65W TDP CPU : <ul style="list-style-type: none"> • Intel® Core™ i7/i5/i3 : -25°C to 55°C (-13°F to 131°F) 80W TDP CPU : <ul style="list-style-type: none"> • Intel® Xeon® E3 : -25°C to 45°C (-13°F to 113°F)
Storage Temperature	-40°C to 85°C (-40°F to 185°F)
Humidity	5% to 95% humidity, non-condensing
Relative Humidity	95% at 60°C
Shock	<ul style="list-style-type: none"> • IEC 60068-2-27 • SSD : 50G @ wallmount, Half-sine, 11ms
Vibration	<ul style="list-style-type: none"> • IEC 60068-2-64 • SSD : 5Grms, 5Hz to 500Hz, 3 Axis
EMC	CE, FCC, EN50155, EN50121-3-2

1.3.10 Specifications of RCS-9412FH GTX1080

System	
Processor	Quad Core Intel® Xeon®/Core™ i7/i5/i3 Processor (Kaby Lake-S/Skylake-S)
Chipset	Intel® C236
BIOS	AMI
SIO	IT8786E
Memory	<ul style="list-style-type: none"> • DDR4 2133MHz • Up to 32GB • 2 204-pin SO-DIMM Socket
I/O Interface	
Serial	4 COM RS-232/422/485 with auto flow control (ESD protection : Air gap ±15kV, Contact ±8kV)
USB	<ul style="list-style-type: none"> • 7 USB 3.0 (6 External, 1 Internal) • 2 USB 2.0 (Internal)
Isolated DIO	32 Isolated DIO (16 DI, 16 DO)
LED	Power, HDD, Wireless
SIM Card	3 SIM Card Socket (2 External, 1 Internal)
Expansion	
Mini PCIe	3 Mini PCIe Socket : <ul style="list-style-type: none"> • 2 Full-size for PCIe/USB/External SIM Card • 1 Full-size for PCIe/USB/Internal SIM Card/mSATA
PCI/PCIe	<ul style="list-style-type: none"> • 2 PCI Slot
Graphics	
Graphics Processor	<ul style="list-style-type: none"> • Intel® HD Graphics 630/530 • NVIDIA® GeForce® GTX 1080
Interface	8 display interfaces : <ul style="list-style-type: none"> • 3 DVI : Up to 1920 x 1200 @ 60Hz • 3 DisplayPort : Up to 7680 x 3480 @ 60Hz • 1 DisplayPort : Up to 4096 x 2304 @ 60Hz • 1 HDMI : Up to 4096 x 2160 @ 60Hz
Storage	
SATA	4 SATA III (6Gbps) support software RAID 0, 1, 5, 10
mSATA	1 SATA III (Mini PCIe Type, 6Gbps)
Storage Device	<ul style="list-style-type: none"> • 1 CFast Socket (Internal) • 4 2.5" SSD/HDD Bracket (Internal)
Audio	
Audio Codec	Realtek ALC888S-VD, 7.1 Channel HD Audio
Audio Interface	1 Mic-in, 1 Line-out

Ethernet	
LAN 1	Intel® I219LM Gigabit LAN supports iAMT 11.0
LAN 2	Intel® I210 Gigabit LAN
Power	
Input Voltage	35W TDP CPU : 12V to 36V, DC-in 65W/80W TDP CPU : 16V to 36V, DC-in
Power Interface	3-pin Terminal Block : V+, V-, Frame Ground
Ignition Control	16 Mode (Internal)
Remote Switch	3-pin Terminal Block : On, Off, IGN
Surge Protection	Up to 80V/1ms Transient Power
Others	
TPM	Optional Infineon SLB9665 supports TPM 2.0, LPC interface
Watchdog Timer	Reset : 1 to 255 sec./min. per step
Smart Management	Wake on LAN, PXE supported
HW Monitor	Monitoring temperature, voltages. Auto throttling control when CPU overheats.
Software Support	
Microsoft	Windows 10, Windows 8.1, Windows 7
Linux	Fedora 13, Ubuntu 10.04 LTS, or Linux Kernel 3.0 above
Mechanical	
Dimension (W x D x H)	172mm x 330mm x 210mm (6.8" x 13" x 8.3")
Weight	5.1 kg (11.2 lb)
Mounting	Wallmount by mounting bracket
Environment	
Operating Temperature	35W TDP CPU : <ul style="list-style-type: none"> • Intel® Xeon® E3 : -25°C to 60°C (-13°F to 140°F) • Intel® Core™ i7/i5/i3 : -25°C to 60°C (-13°F to 140°F) 65W TDP CPU : <ul style="list-style-type: none"> • Intel® Core™ i7/i5/i3 : -25°C to 55°C (-13°F to 131°F) 80W TDP CPU : <ul style="list-style-type: none"> • Intel® Xeon® E3 : -25°C to 45°C (-13°F to 113°F)
Storage Temperature	-40°C to 85°C (-40°F to 185°F)
Humidity	5% to 95% humidity, non-condensing
Relative Humidity	95% at 55°C
Shock	<ul style="list-style-type: none"> • IEC 60068-2-27 • SSD : 50G @ wallmount, Half-sine, 11ms
Vibration	<ul style="list-style-type: none"> • IEC 60068-2-64 • SSD : 5Grms, 5Hz to 500Hz, 3 Axis
EMC	CE, FCC, EN50155, EN50121-3-2

1.3.11 Specifications of RCS-9412FR GTX1080

System	
Processor	Quad Core Intel® Xeon®/Core™ i7/i5/i3 Processor (Kaby Lake-S/Skylake-S)
Chipset	Intel® C236
BIOS	AMI
SIO	IT8786E
Memory	<ul style="list-style-type: none"> • DDR4 2133MHz • Up to 32GB • 2 204-pin SO-DIMM Socket
I/O Interface	
Serial	4 COM RS-232/422/485 with auto flow control (ESD protection : Air gap ±15kV, Contact ±8kV)
USB	<ul style="list-style-type: none"> • 7 USB 3.0 (6 External, 1 Internal) • 2 USB 2.0 (Internal)
Isolated DIO	32 Isolated DIO (16 DI, 16 DO)
LED	Power, HDD, Wireless
SIM Card	3 SIM Card Socket (2 External, 1 Internal)
Expansion	
Mini PCIe	3 Mini PCIe Socket : <ul style="list-style-type: none"> • 2 Full-size for PCIe/USB/External SIM Card • 1 Full-size for PCIe/USB/Internal SIM Card/mSATA
PCI/PCIe	<ul style="list-style-type: none"> • 2 PCI Slot
Graphics	
Graphics Processor	<ul style="list-style-type: none"> • Intel® HD Graphics 630/530 • NVIDIA® GeForce® GTX 1080
Interface	8 display interfaces : <ul style="list-style-type: none"> • 3 DVI : Up to 1920 x 1200 @ 60Hz • 3 DisplayPort : Up to 7680 x 3480 @ 60Hz • 1 DisplayPort : Up to 4096 x 2304 @ 60Hz • 1 HDMI : Up to 4096 x 2160 @ 60Hz
Storage	
SATA	4 SATA III (6Gbps) support software RAID 0, 1, 5, 10
mSATA	1 SATA III (Mini PCIe Type, 6Gbps)
Storage Device	<ul style="list-style-type: none"> • 1 CFast Socket (Internal) • 4 2.5" SSD/HDD Tray
Audio	
Audio Codec	Realtek ALC888S-VD, 7.1 Channel HD Audio
Audio Interface	1 Mic-in, 1 Line-out

Ethernet	
LAN 1	Intel® I219LM Gigabit LAN supports iAMT 11.0
LAN 2	Intel® I210 Gigabit LAN
Power	
Input Voltage	35W TDP CPU : 12V to 36V, DC-in 65W/80W TDP CPU : 16V to 36V, DC-in
Power Interface	3-pin Terminal Block : V+, V-, Frame Ground
Ignition Control	16 Mode (Internal)
Remote Switch	3-pin Terminal Block : On, Off, IGN
Surge Protection	Up to 80V/1ms Transient Power
Others	
TPM	Optional Infineon SLB9665 supports TPM 2.0, LPC interface
Watchdog Timer	Reset : 1 to 255 sec./min. per step
Smart Management	Wake on LAN, PXE supported
HW Monitor	Monitoring temperature, voltages. Auto throttling control when CPU overheats.
Software Support	
Microsoft	Windows 10, Windows 8.1, Windows 7
Linux	Fedora 13, Ubuntu 10.04 LTS, or Linux Kernel 3.0 above
Mechanical	
Dimension (W x D x H)	172mm x 330mm x 210mm (6.8" x 13" x 8.3")
Weight	5.6 kg (12.3 lb)
Mounting	Wallmount by mounting bracket
Environment	
Operating Temperature	35W TDP CPU : <ul style="list-style-type: none"> • Intel® Xeon® E3 : -25°C to 60°C (-13°F to 140°F) • Intel® Core™ i7/i5/i3 : -25°C to 60°C (-13°F to 140°F) 65W TDP CPU : <ul style="list-style-type: none"> • Intel® Core™ i7/i5/i3 : -25°C to 55°C (-13°F to 131°F) 80W TDP CPU : <ul style="list-style-type: none"> • Intel® Xeon® E3 : -25°C to 45°C (-13°F to 113°F)
Storage Temperature	-40°C to 85°C (-40°F to 185°F)
Humidity	5% to 95% humidity, non-condensing
Relative Humidity	95% at 60°C
Shock	<ul style="list-style-type: none"> • IEC 60068-2-27 • SSD : 50G @ wallmount, Half-sine, 11ms
Vibration	<ul style="list-style-type: none"> • IEC 60068-2-64 • SSD : 5Grms, 5Hz to 500Hz, 3 Axis
EMC	CE, FCC, EN50155, EN50121-3-2

1.3.12 Specifications of RCS-9412FHR GTX1080

System	
Processor	Quad Core Intel® Xeon®/Core™ i7/i5/i3 Processor (Kaby Lake-S/Skylake-S)
Chipset	Intel® C236
BIOS	AMI
SIO	IT8786E
Memory	<ul style="list-style-type: none"> • DDR4 2133MHz • Up to 32GB • 2 204-pin SO-DIMM Socket
I/O Interface	
Serial	4 COM RS-232/422/485 with auto flow control (ESD protection : Air gap ±15kV, Contact ±8kV)
USB	<ul style="list-style-type: none"> • 7 USB 3.0 (6 External, 1 Internal) • 2 USB 2.0 (Internal)
Isolated DIO	32 Isolated DIO (16 DI, 16 DO)
LED	Power, HDD, Wireless
SIM Card	3 SIM Card Socket (2 External, 1 Internal)
Expansion	
Mini PCIe	3 Mini PCIe Socket : <ul style="list-style-type: none"> • 2 Full-size for PCIe/USB/External SIM Card • 1 Full-size for PCIe/USB/Internal SIM Card/mSATA
PCI/PCIe	<ul style="list-style-type: none"> • 2 PCI Slot
Graphics	
Graphics Processor	<ul style="list-style-type: none"> • Intel® HD Graphics 630/530 • NVIDIA® GeForce® GTX 1080
Interface	8 display interfaces : <ul style="list-style-type: none"> • 3 DVI : Up to 1920 x 1200 @ 60Hz • 3 DisplayPort : Up to 7680 x 3480 @ 60Hz • 1 DisplayPort : Up to 4096 x 2304 @ 60Hz • 1 HDMI : Up to 4096 x 2160 @ 60Hz
Storage	
SATA	4 SATA III (6Gbps) support software RAID 0, 1, 5, 10
mSATA	1 SATA III (Mini PCIe Type, 6Gbps)
Storage Device	<ul style="list-style-type: none"> • 1 CFast Socket (Internal) • 4 2.5" SSD/HDD Tray
Audio	
Audio Codec	Realtek ALC888S-VD, 7.1 Channel HD Audio
Audio Interface	1 Mic-in, 1 Line-out

Ethernet	
LAN 1	Intel® I219LM Gigabit LAN supports iAMT 11.0
LAN 2	Intel® I210 Gigabit LAN
Power	
Input Voltage	35W TDP CPU : 12V to 36V, DC-in 65W/80W TDP CPU : 16V to 36V, DC-in
Power Interface	3-pin Terminal Block : V+, V-, Frame Ground
Ignition Control	16 Mode (Internal)
Remote Switch	3-pin Terminal Block : On, Off, IGN
Surge Protection	Up to 80V/1ms Transient Power
Others	
TPM	Optional Infineon SLB9665 supports TPM 2.0, LPC interface
Watchdog Timer	Reset : 1 to 255 sec./min. per step
Smart Management	Wake on LAN, PXE supported
HW Monitor	Monitoring temperature, voltages. Auto throttling control when CPU overheats.
Software Support	
Microsoft	Windows 10, Windows 8.1, Windows 7
Linux	Fedora 13, Ubuntu 10.04 LTS, or Linux Kernel 3.0 above
Mechanical	
Dimension (W x D x H)	172mm x 330mm x 210mm (6.8" x 13" x 8.3")
Weight	6.3 kg (13.9 lb)
Mounting	Wallmount by mounting bracket
Environment	
Operating Temperature	35W TDP CPU : <ul style="list-style-type: none"> • Intel® Xeon® E3 : -25°C to 60°C (-13°F to 140°F) • Intel® Core™ i7/i5/i3 : -25°C to 60°C (-13°F to 140°F) 65W TDP CPU : <ul style="list-style-type: none"> • Intel® Core™ i7/i5/i3 : -25°C to 55°C (-13°F to 131°F) 80W TDP CPU : <ul style="list-style-type: none"> • Intel® Xeon® E3 : -25°C to 45°C (-13°F to 113°F)
Storage Temperature	-40°C to 85°C (-40°F to 185°F)
Humidity	5% to 95% humidity, non-condensing
Relative Humidity	95% at 55°C
Shock	<ul style="list-style-type: none"> • IEC 60068-2-27 • SSD : 50G @ wallmount, Half-sine, 11ms
Vibration	<ul style="list-style-type: none"> • IEC 60068-2-64 • SSD : 5Grms, 5Hz to 500Hz, 3 Axis
EMC	CE, FCC, EN50155, EN50121-3-2

1.4 Supported CPU List

Processor No.	TDP	Cache	Max. Frequency	Embedded
Xeon® E3-1275 v6	73W	8M	Up to 4.20 GHz	Yes
Xeon® E3-1275 v5	80W	8M	Up to 4.00 GHz	Yes
Xeon® E3-1225 v5	80W	8M	Up to 3.70 GHz	Yes
Xeon® E3-1225L v5	35W	8M	Up to 3.40 GHz	Yes
Core™ i7-7700	65W	8M	Up to 4.20 GHz	Yes
Core™ i7-7700T	65W	8M	Up to 3.80 GHz	Yes
Core™ i7-6700	65W	8M	Up to 4.00 GHz	Yes
Core™ i7-6700	65W	8M	Up to 4.00 GHz	Yes
Core™ i7-6700TE	35W	8M	Up to 3.40 GHz	Yes
Core™ i5-6500	65W	6M	Up to 3.60 GHz	Yes
Core™ i5-6500TE	35W	6M	up to 3.30 GHz	Yes
Core™ i3-6100	51W	3M	3.70 GHz	Yes
Core™ i3-6100TE	35W	4M	2.70 GHz	Yes

1.5 Mechanical Dimension

1.5.1 Dimensions of RCS-9430F GTX1080/RCS-9421F GTX1080/ RCS-9412F GTX1080

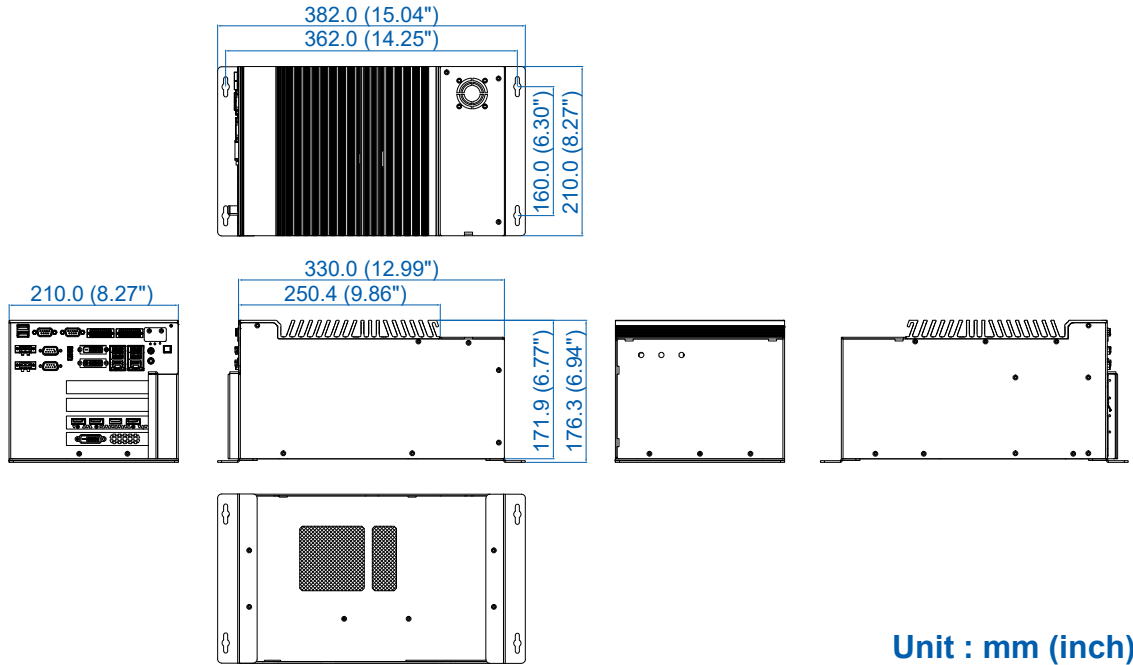

1.5.2 Dimensions of RCS-9430FH GTX1080/RCS-9421FH GTX1080/ RCS-9412FH GTX1080

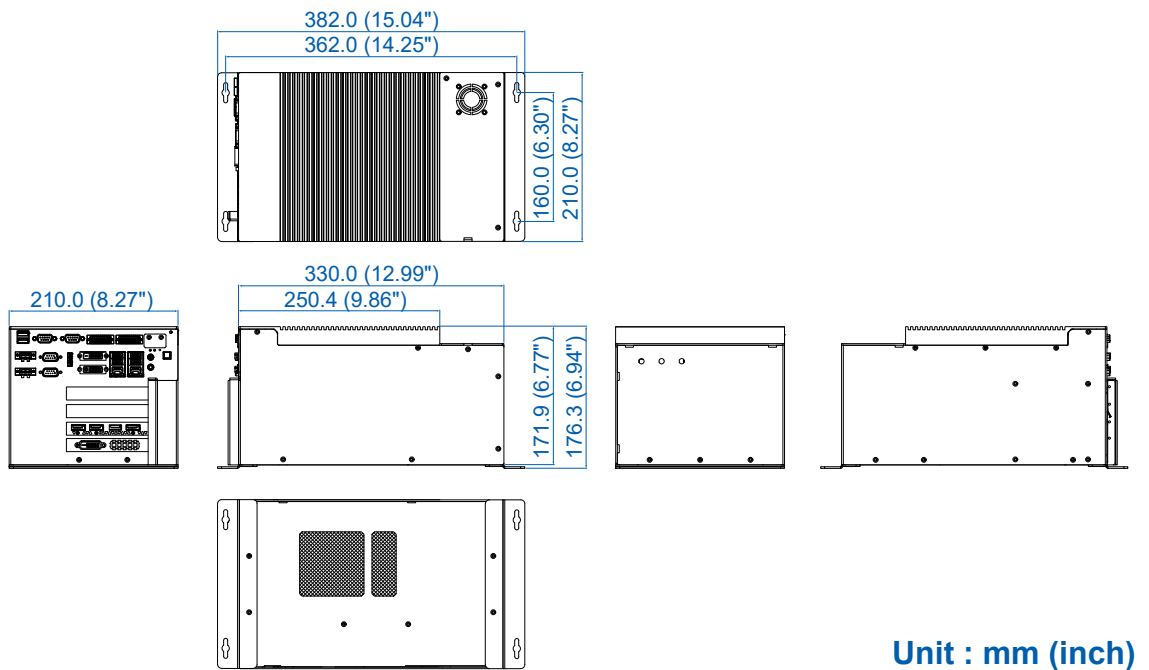

1.5.3 Dimensions of RCS-9430FR GTX1080/RCS-9421FR GTX1080/ RCS-9412FR GTX1080

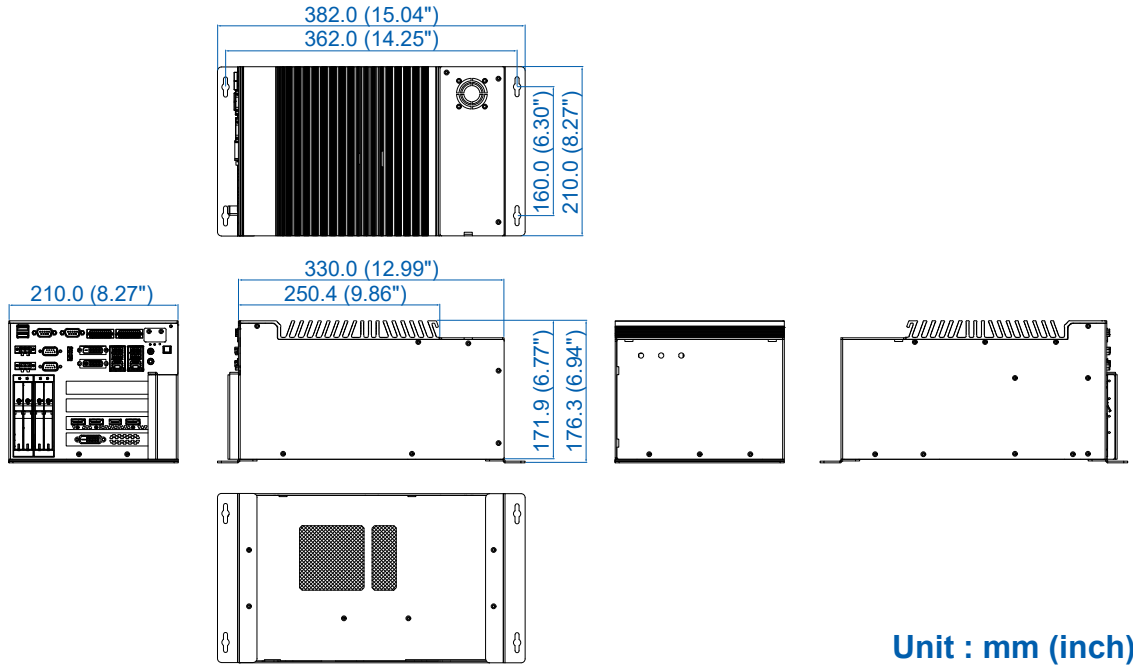

1.5.4 Dimensions of RCS-9430FHR GTX1080/RCS-9421FHR GTX1080/ RCS-9412FHR GTX1080

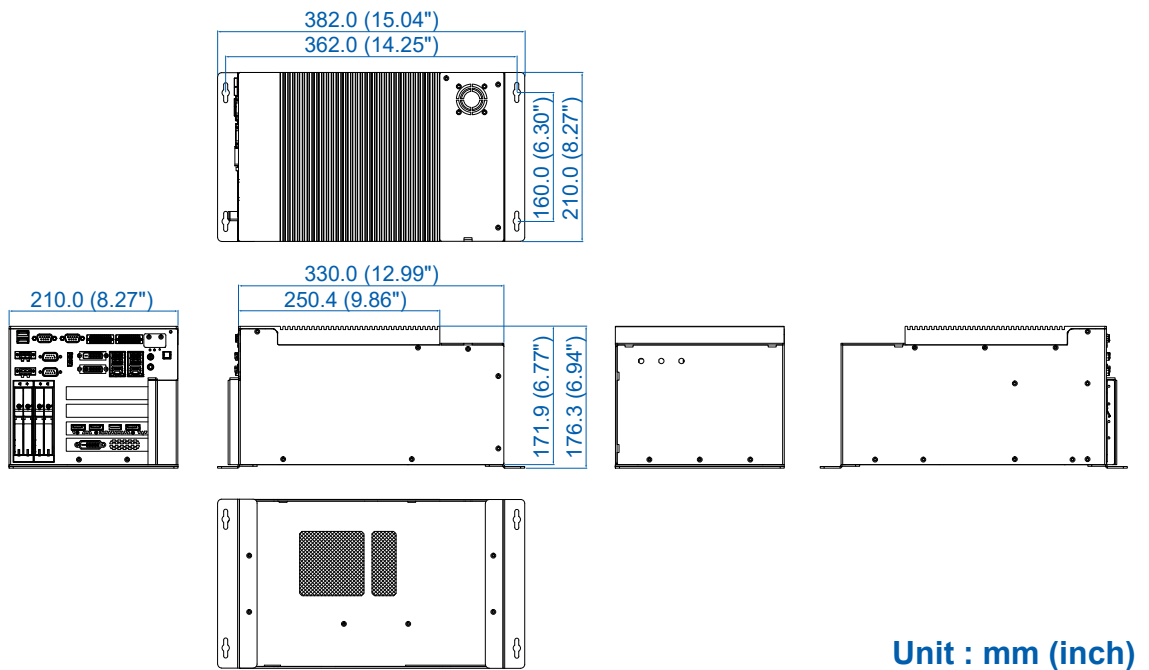

2

GETTING TO KNOW YOUR RCS-9000F GTX1080

2.1 Packing List

Item	Description	Qty
1	RCS-9000F GTX1080 GPU Computing System (According to the configuration you order, the RCS-9000F GTX1080 series may contain SSD/HDD and DDR4 SO-DIMM. Please verify these items if necessary.)	1
2	RCS-9400F Series Accessory box, which contains <ul style="list-style-type: none">• Vecow Drivers & Utilities DVD• Wall-mounting bracket• F#6-32x6 screw for wall-mounting bracket• PH-M2.5x6 screw for Mini PCIe Slot• PH-M4x16.5 for Din Rail• M3x11 Spring screws for CPU• Terminal block plug pitch 2.54mm 2x10pin• Terminal block plug pitch 5.0mm 3pin• Foot Pad• EPE• Plastic Bag• F-M3x4 for SSD/HDD with bracket	1 2 4 6 4 5 2 2 4 2 1 16
3	RCS-9400FR Series Accessory box, which contains <ul style="list-style-type: none">• Vecow Drivers & Utilities DVD• Wall-mounting bracket• F#6-32x6 screw for wall-mounting bracket• PH-M2.5x6 screw for Mini PCIe Slot• PH-M4x16.5 for Din Rail• M3x11 Spring screws for CPU• Terminal block plug pitch 2.54mm 2x10pin• Terminal block plug pitch 5.0mm 3pin• Foot Pad• EPE• Plastic Bag• Removable HDD Tray Key	1 2 4 6 4 5 2 2 4 2 1 2

2.2 Front Panel I/O & Functions

In Vecow's RCS-9000 series family, all I/O connectors are located on the front panel. Most of the general connections to the computer device, such as audio, USB, DVI-I, DVI-D, DisplayPort, and any additional storage, are placed on the front panel.

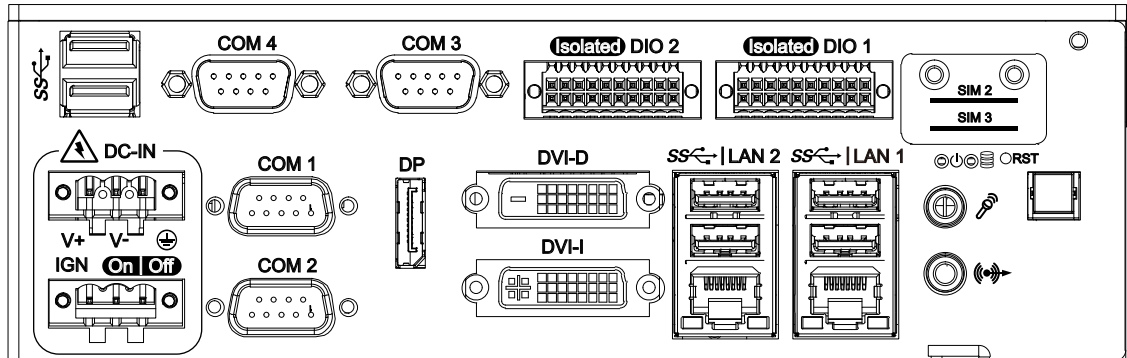

2.2.1 Power Button

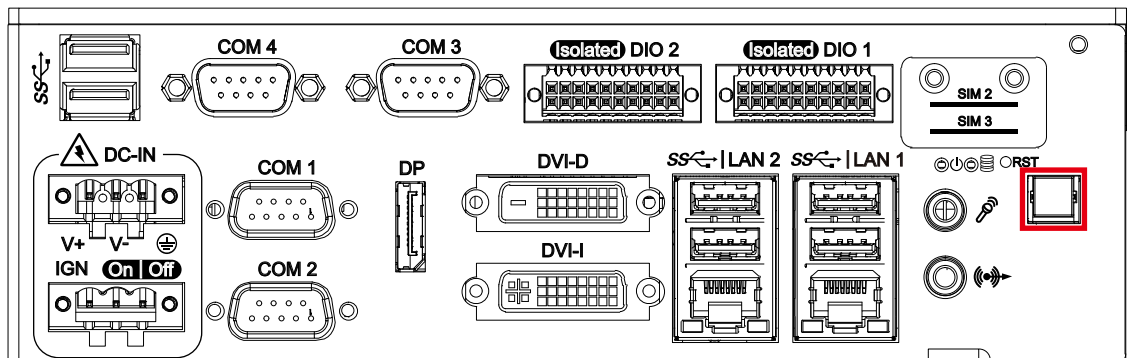

The power button is a non-latched switch with dual color LED indication. It indicates power statuses : S0, S3 and S5. More details on the LED indications are listed in the following chart

LED Color	Power Status	System Status
Solid Blue	S0	System working
Solid Orange	S3, S5	Suspend to RAM, System off with standby power

To power on RCS-9000, press the power button which will light the blue LED. To power off RCS-9000, you can either command shutdown by OS operation or simply press the power button. If system error appears, press and hold the power button for four seconds to shut down the machine directly. Please do note that a four-second interval between each two power-on/power-off operation is necessary in normal working status. (For example, once turning off the system, you have to wait for four seconds to initiate another power-on operation).

2.2.2 Reset Tact Switch

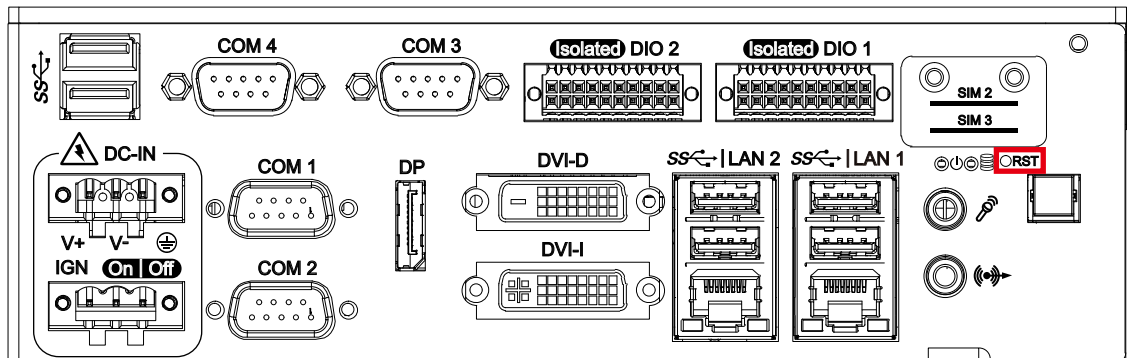

The item circled red is a hardware reset switch. Use this switch to reset the system without powering off the RCS-9000. Press and hold the reset switch for a few seconds, then reset will be enabled.

2.2.3 DVI-D Connector

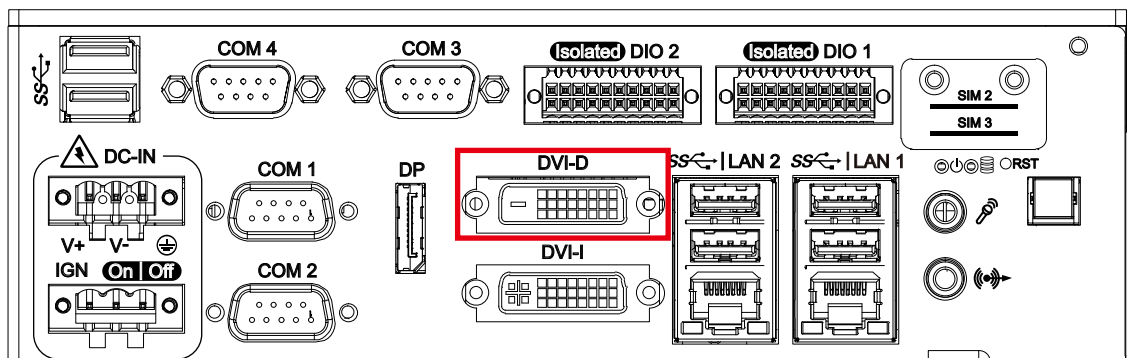

This connector can output DVI signals. The DVI output mode supports up to 1920x1200 resolution. The DVI mode is automatically selected according to the display device connected. You will need a DVI cable when connecting to a display device.

2.2.4 PWR & HDD LED Indicator

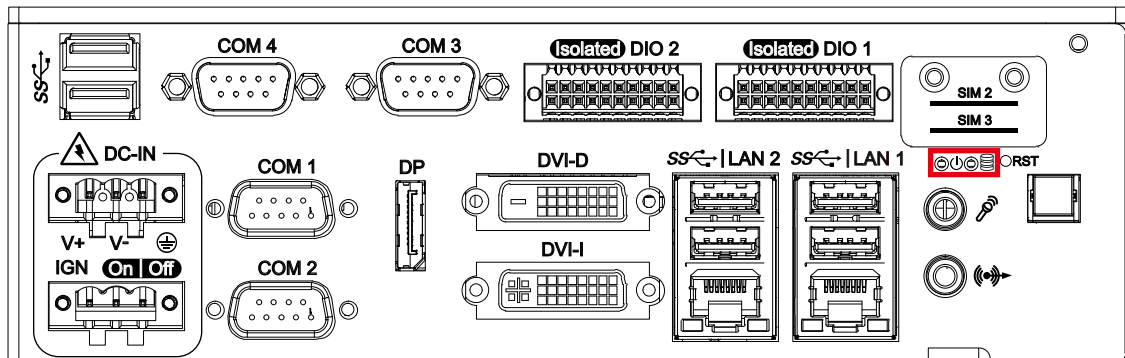

Yellow-HDD LED : A hard disk/CFast LED. If the LED is on, it indicates that the system's storage is functional. If it is off, it indicates that the system's storage is not functional. If it is flashing, it indicates data access activities are in progress.

Green-Power LED : If the LED is solid green, it indicates that the system is powered on.

LED Color	Indication	System Status
Yellow	HDD/CFast	<ul style="list-style-type: none"> On/Off : Storage status, function or not Twinkling : Data transferring
Green	Power	System power status (on/off)

2.2.5 DVI-I Connector

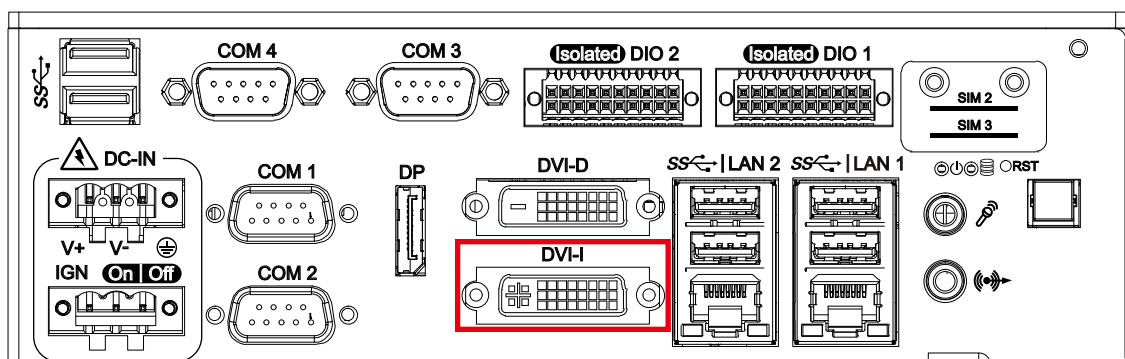

The DVI-I connector on the front panel supports both DVI and VGA display modes. This connector can output DVI signals. The DVI output mode supports up to 1920x1200 resolution. The DVI mode is automatically selected according to the display device connected. You will need a DVI-I cable when connecting to a display device.

2.2.6 DisplayPort

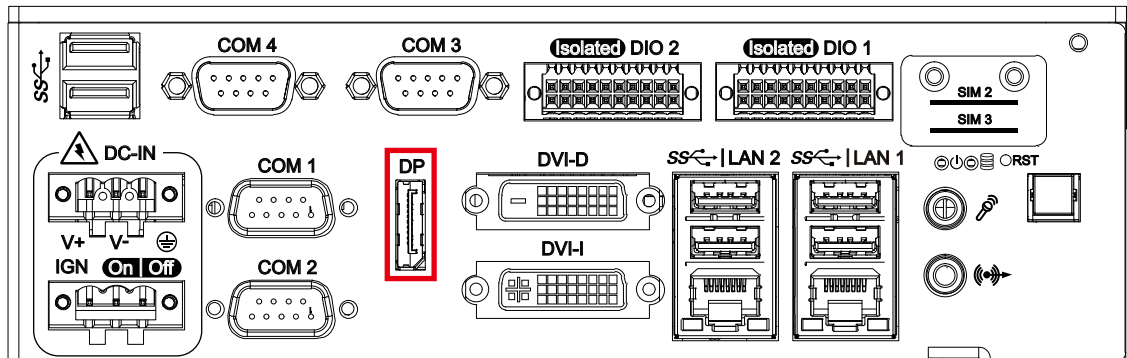

Onboard DisplayPort connection supports up to 4096 x 2304 resolution at 60Hz.

2.2.7 USB 3.0

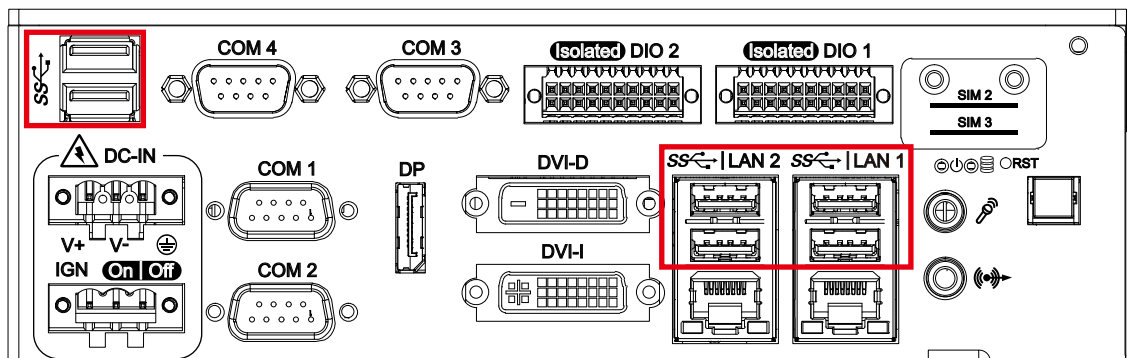

There are six USB 3.0 connections available, supporting up to 5GB per second data rates on the front side of the RCS-9000. It is also compliant with the requirements of super speed (SS), high speed (HS), full speed (FS), and low speed (LS).

2.2.8 SIM 1, SIM 2, SIM 3

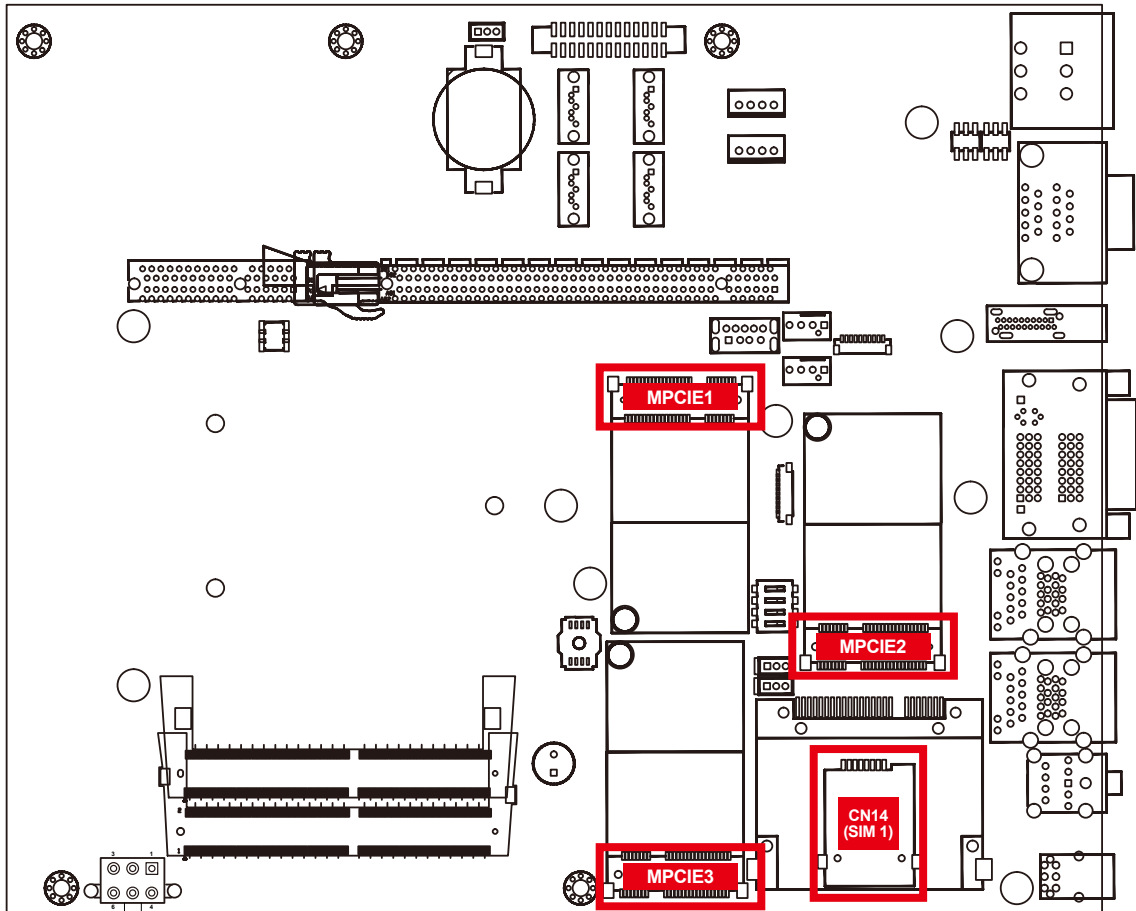
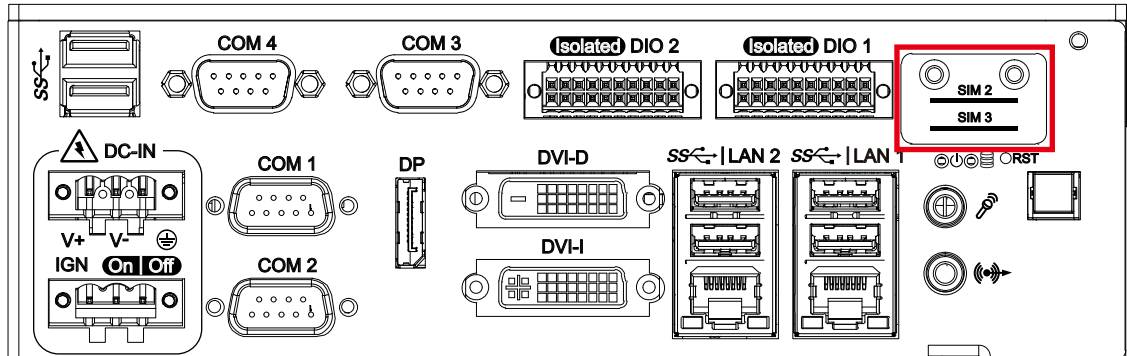

Mini PCIe	SIM
MPCIE1	CN14 (SIM 1)
MPCIE2	CN6 (SIM 2)
MPCIE3	CN7 (SIM 3)

2.2.9 10/100/1000 Mbps Ethernet Port

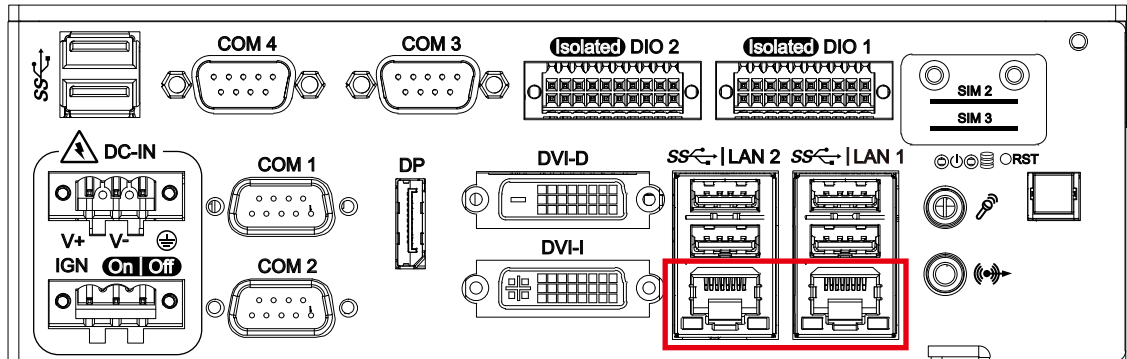

There are two 8-pin RJ-45 jacks supporting 10/100/1000 Mbps Ethernet connections on the front side of RCS-9000. LAN 1 is powered by Intel® I219LM Ethernet engine, and LAN 2 is powered by Intel I210 Ethernet engine. When LAN 1 works in normal status, iAMT 11.0 function is enabled. When LAN 2 works in normal status, iAMT 8.0 function is enabled.

Using suitable RJ-45 cable, you can connect the RCS-9000 system to a computer or to any other devices with Ethernet connection, for example, a hub or a switch. Moreover, both LAN 1 and LAN 2 support "Wake" on LAN and preboot functions. The pinouts of LAN 1 and LAN 2 are listed in the following chart :

Pin No.	10/100Mbps	1000Mbps
1	E_TX+	MDI0_P
2	E_TX-	MDI0_N
3	E_RX+	MDI1_P
4	----	MDI2_P
5	----	MDI2_N
6	E_RX-	MDI1_N
7	----	MDI3_P
8	----	MDI3_N

Each LAN port is supported by standard RJ-45 connector with LED indicators to present Active/Link/Speed status of the connection.

The LED indicator on the right bottom corner lightens in solid green when the cable is properly connected to a 100 Mbps Ethernet network; The LED indicator on the right bottom corner lightens in solid orange when the cable is properly connected to a 1000Mbps Ethernet network; The left LED will keep twinkling/off when Ethernet data packets are being transmitted/received.

LED Location	LED Color	10Mbps	100Mbps	1000Mbps
Right	Green/Orange	Off	Solid Green	Solid Orange
Left	Yellow	Blinking Yellow	Blinking Yellow	Blinking Yellow

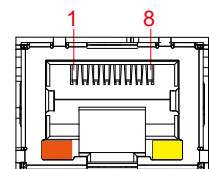

2.2.10 Audio Connector

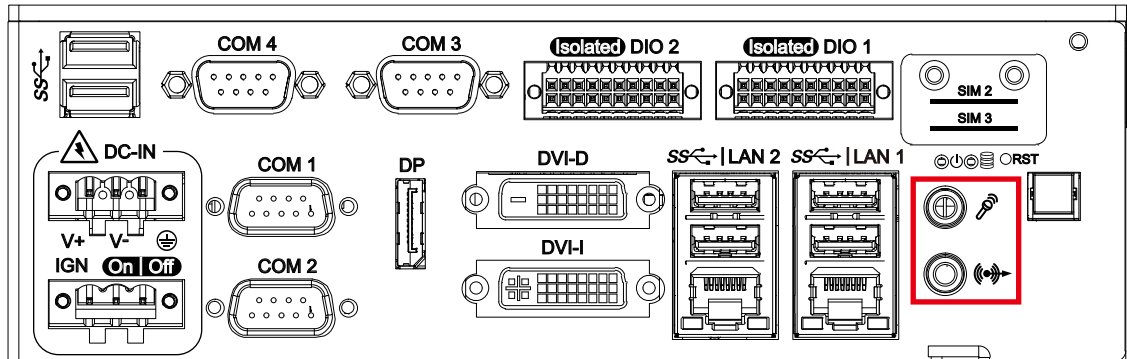

There are two audio connectors, mic-in and line-out, on the front side of RCS- 9000. Onboard Realtek ALC888S-VD audio codec supports 7.1 channel HD audio and fully complies with Intel® High Definition Audio (Azalia) specifications. To utilize the audio function on the Windows platform, you need to install corresponding drivers for both Intel® C236 chipset and Realtek ALC888S-VD codec. Please refer to chapter four for more details on driver installation.

2.2.11 Front-access SSD/HDD Tray

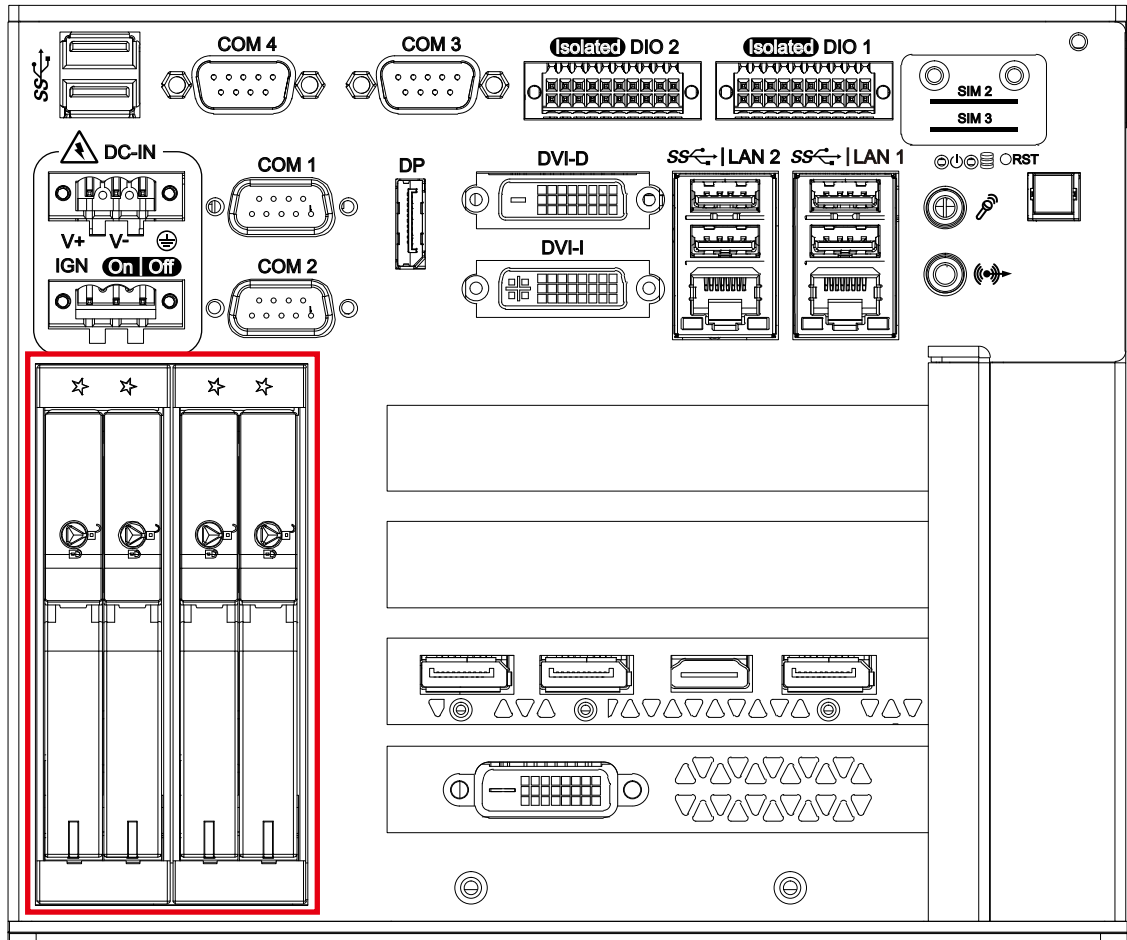

There are four front-access 2.5" SSD/HDD trays on the front side of RCS-9000. Press the trigger to open the SSD/HDD tray which has up to 8TB available.

2.2.12 Power Terminal Block

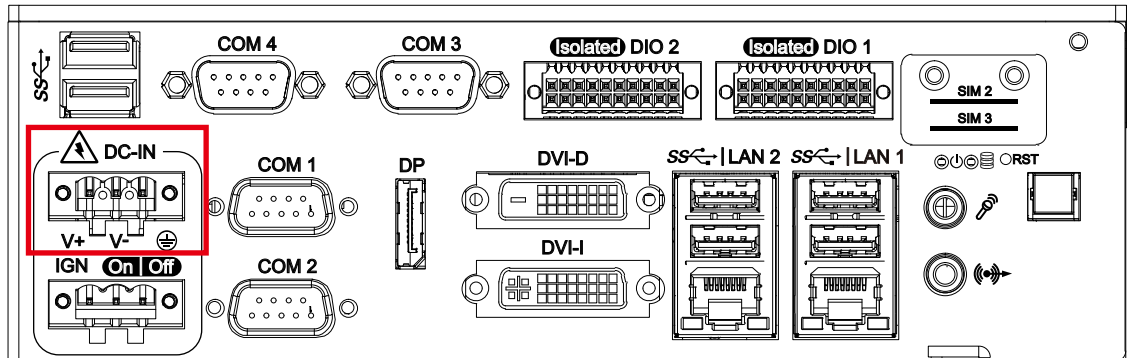

RCS-9000 supports 6V to 36V DC power input.

Pin No.	Definition	Pin No.	Definition
1	V+	2	V-
3	Earth GND		

2.2.13 Remote Power On/Off Switch

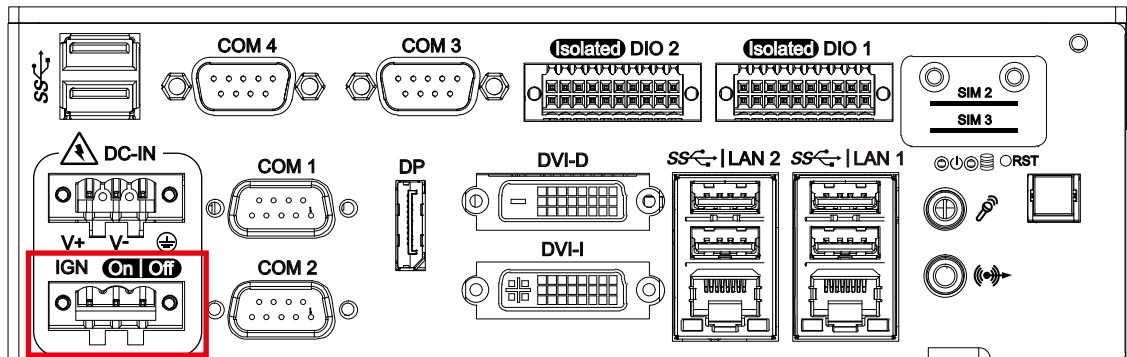

It is a 2-pin power-on/power-off switch through Phoenix Contact terminal block. You could turn on or off the system power by using this contact. This terminal block supports dual function on soft power-on/power-off (instant off or delay four seconds), and suspend mode.

Pin No.	Definition	Pin No.	Definition
1	IGNITION	2	SW+
3	SW-		

2.2.14 Isolated DIO

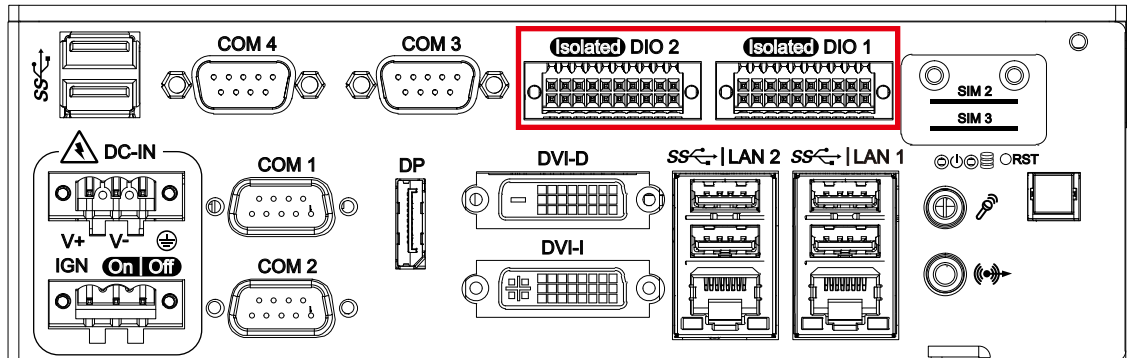

There is a 16-bit DIO (8-bit DI, 8-bit DO) connector in the rear side. Each DIO channel is equipped with a photocoupler for isolated protection. A power buffer device TPD2007F integrated in 8-DO circuit for motors, solenoids, and lamp driver applications.

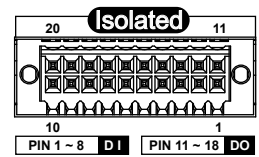

Pin No.	Definition	Pin No.	Definition
1	INPUT 0	11	OUTPUT 0
2	INPUT 1	12	OUTPUT 1
3	INPUT 2	13	OUTPUT 2
4	INPUT 3	14	OUTPUT 3
5	INPUT 4	15	OUTPUT 4
6	INPUT 5	16	OUTPUT 5
7	INPUT 6	17	OUTPUT 6
8	INPUT 7	18	OUTPUT 7
9	DI_COM	19	DIO_GND
10	DIO_GND	20	External 24V to 78V DC Input

GPI SINK Mode

Isolated GPI input circuit in SINK mode (NPN) is illustrated as follows :

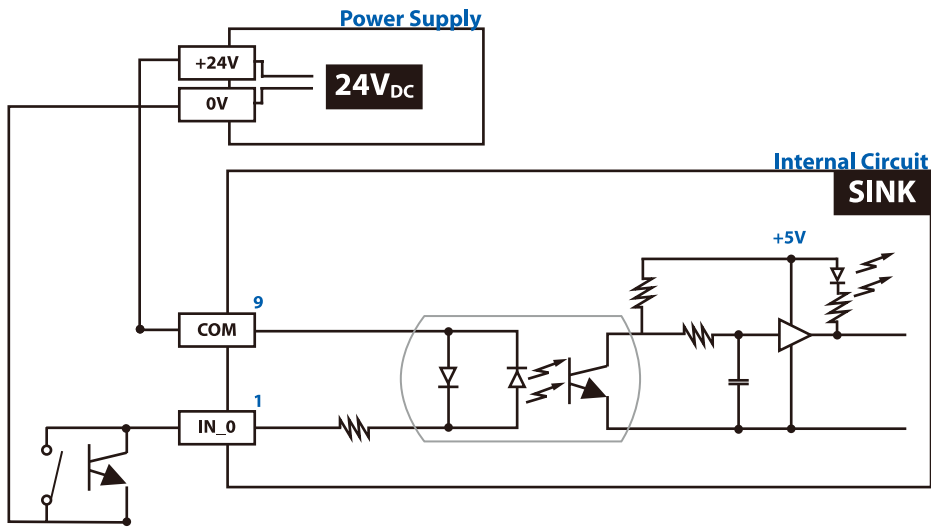

GPI SOURCE Mode

Digital GPI input signal circuit in SOURCE mode (PNP) is illustrated as follows :

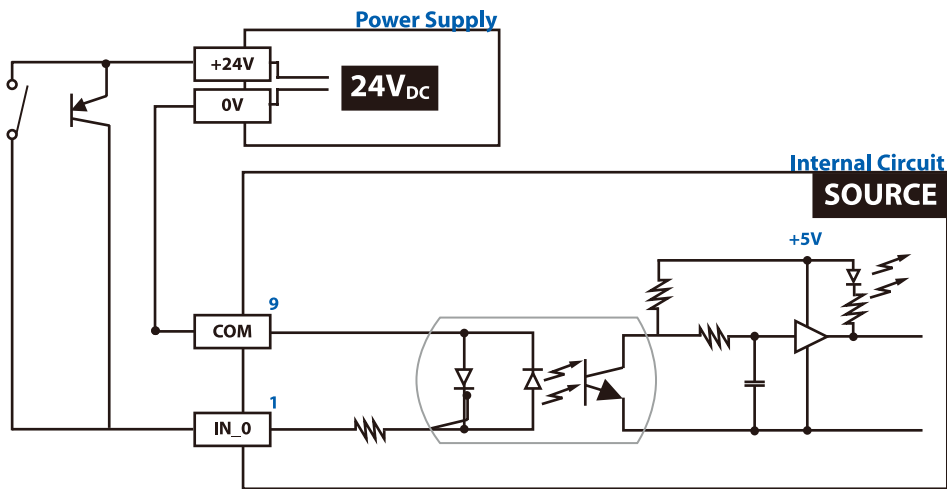

GPO SINK Mode

Digital GPO output circuit in SINK mode (NPN) is illustrated as follows :

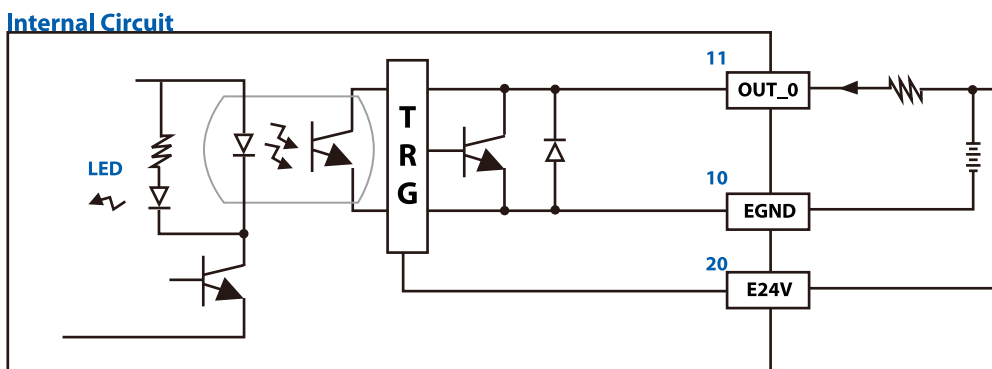

2.2.15 Serial Port COM

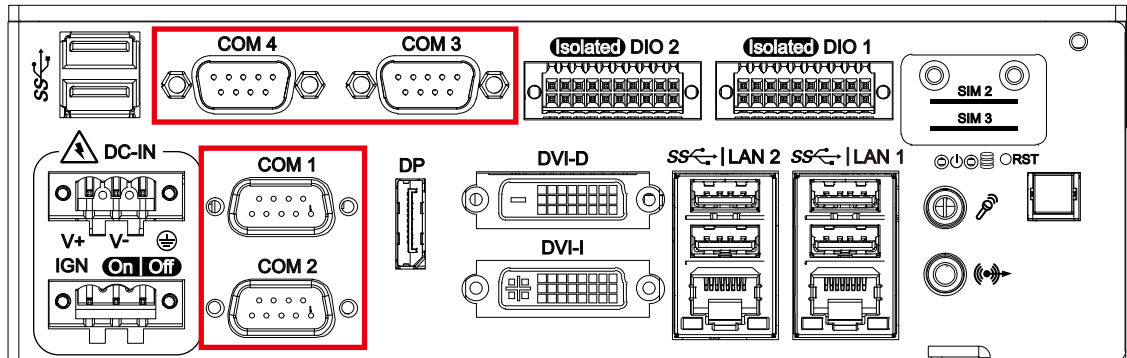

Serial port can be configured for RS-232, RS-422, or RS-485 with auto flow control communication. The default definition is RS-232, if you want to change to RS-422 or RS-485, you can find the setting in BIOS.

BIOS Setting	Function
COM 1	RS-232
COM 2	RS-422 (5-wire)
COM 3	RS-422 (9-wire)
COM 4	RS-485
	RS-485 w/z auto-flow control

The pin assignments are listed in the table as follows :

Serial Port	Pin No.	RS-232	RS-422 (5-wire)	RS-422 (9-wire)	RS-485 (3-wire)
1 to 4	1	DCD	TXD-	TXD-	DATA-
	2	RXD	TXD+	TXD+	DATA+
	3	TXD	RXD+	RXD+	-----
	4	DTR	RXD-	RXD-	-----
	5	GND	GND	GND	GND
	6	DSR	-----	RTS-	-----
	7	RTS	-----	RTS+	-----
	8	CTS	-----	CTS+	-----
	9	RI	-----	CTS-	-----

2.3 Main Board Expansion Connectors

2.3.1 Front View of RCS-9000 Main Board With Connector Location

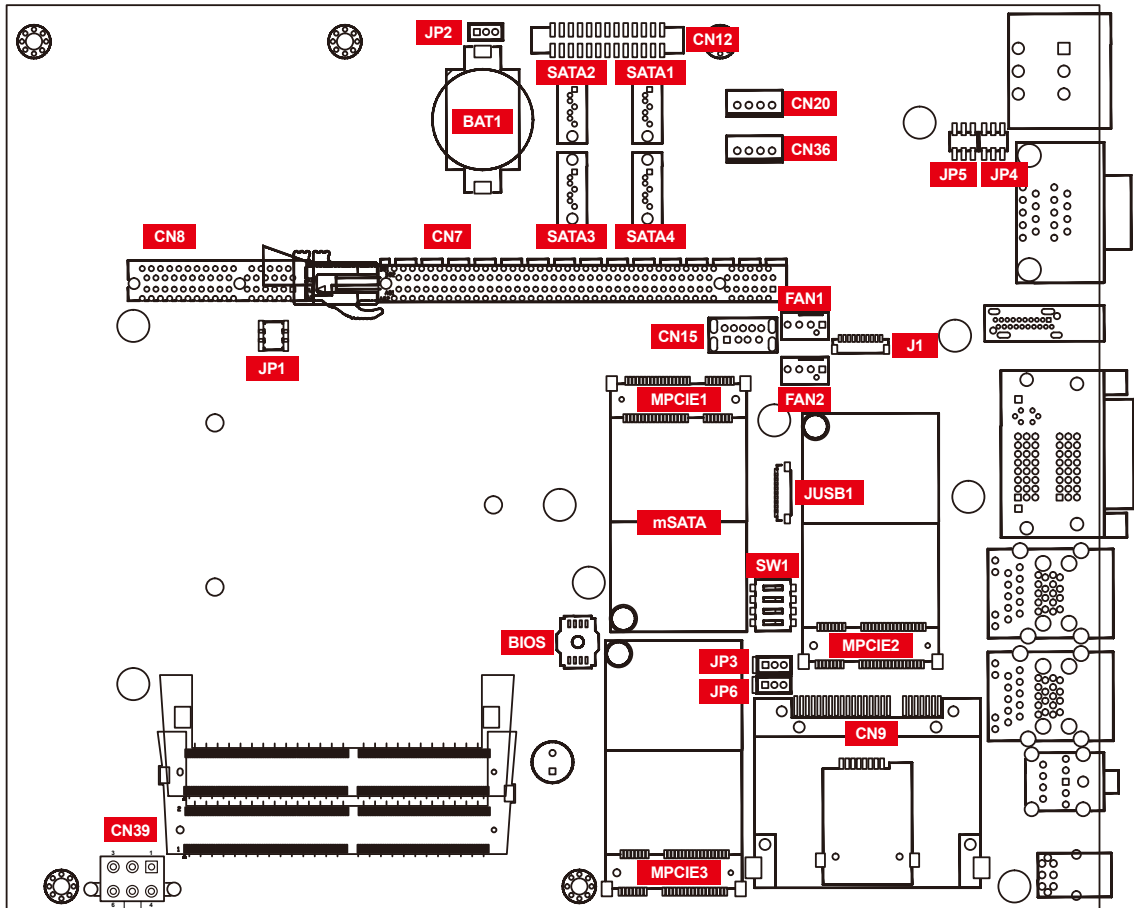

2.3.2 Rear View of RCS-9000 Main Board With Connector Location

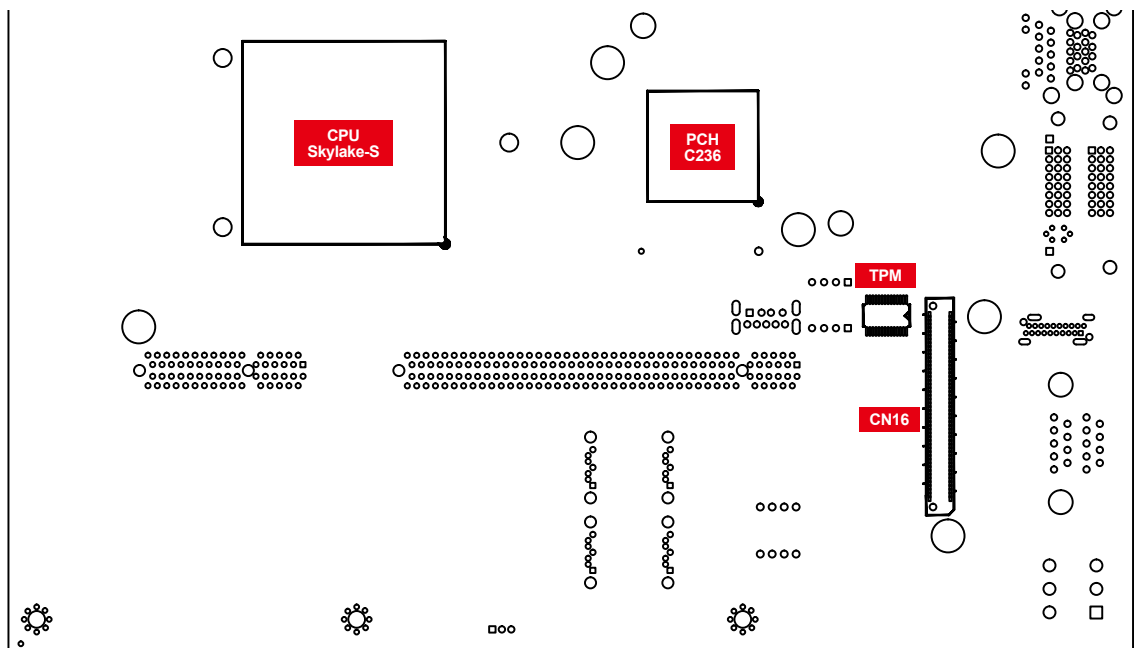

2.3.3 CN12 : GPIO

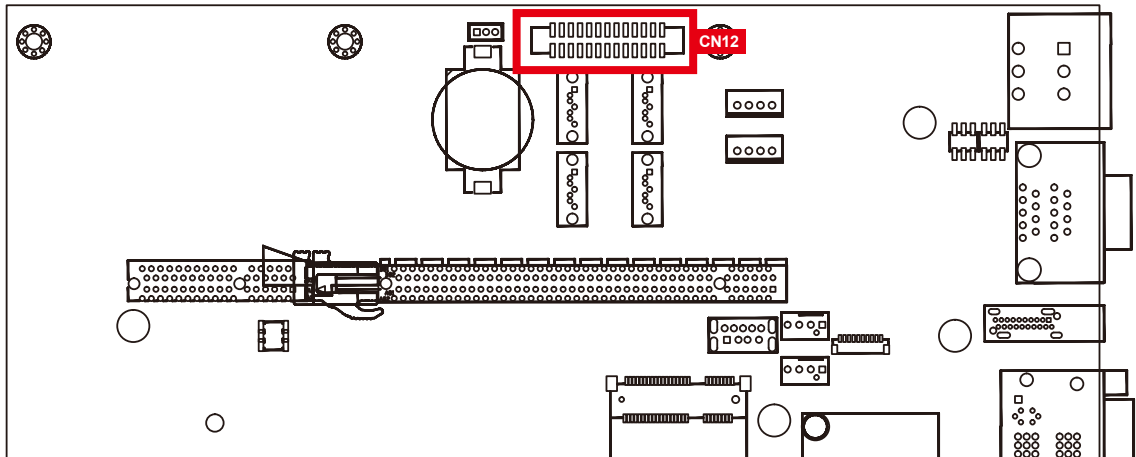

The RCS-9000 offers sixteen programmable I/O within TTL 5V tolerance. If the GPIO is logic high, it indicates that the mapping on SIO GPIO pin is logic high level. If the GPIO is logic low, it indicates that the mapping on SIO GPIO pin is logic low level.

Pin No.	Function	Pin No.	Function
1	GND	14	GND
2	SIO_GPO77	15	SIO_GPI87
3	SIO_GPO76	16	SIO_GPI86
4	SIO_GPO75	17	SIO_GPI85
5	SIO_GPO74	18	SIO_GPI84
6	GND	19	GND
7	SIO_GPO73	20	SIO_GPI83
8	SIO_GPO72	21	SIO_GPI82
9	SIO_GPO71	22	SIO_GPI81
10	SIO_GPO70	23	SIO_GPI80
11	GND	24	GND
12	SMBDATA	25	+V5S
13	SMBCLK	26	+V5S

2.3.4 SYS_FAN1, SYS_FAN2

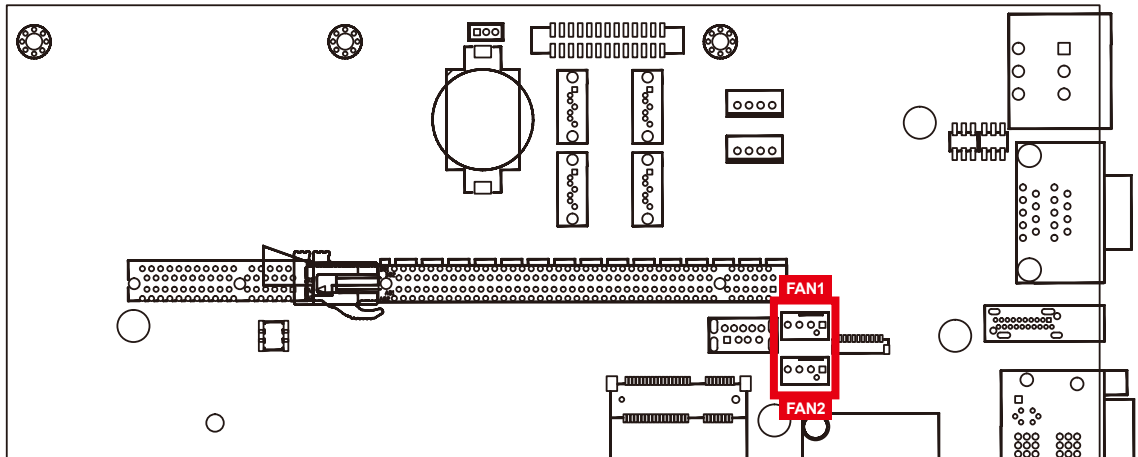

The fan power connector is for additional thermal requirements. The pin assignments of SYS_FAN1 and SYS_FAN2 are listed in the following table :

Pin No.	Function	Pin No.	Function
1	GND	3	Fan speed sensor (Input)
2	+12V (up to 2A)	4	Fan speed sensor (ouput)

2.3.5 BAT1 : Battery

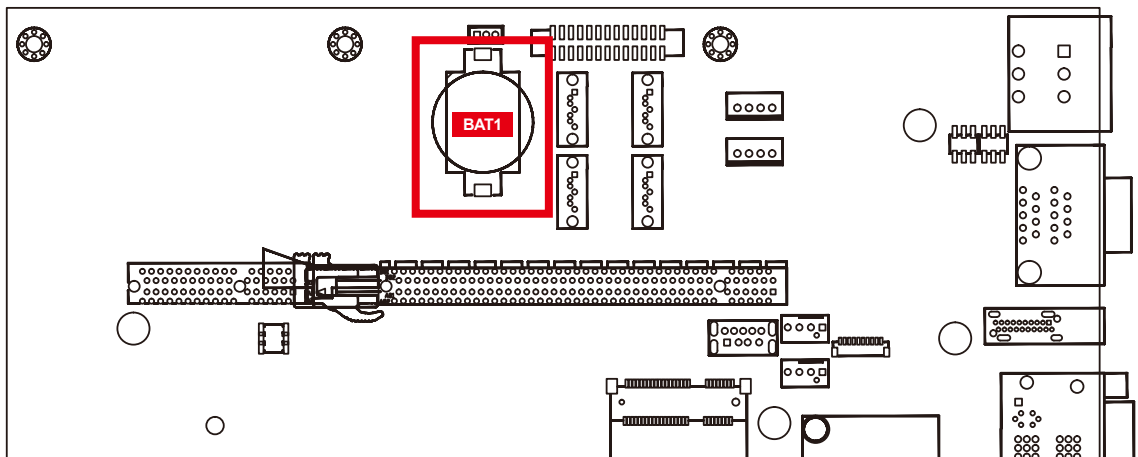

The RCS-9000's real-time clock is powered by a lithium battery. It is equipped with Panasonic BR2032 190mAh lithium battery. It is recommended that you do not replace the lithium battery on your own. If the battery needs to be changed, please contact the Vecow RMA service team.

2.3.6 CN8 : One PCIe x4 or Four PCIe x1 (PCH)

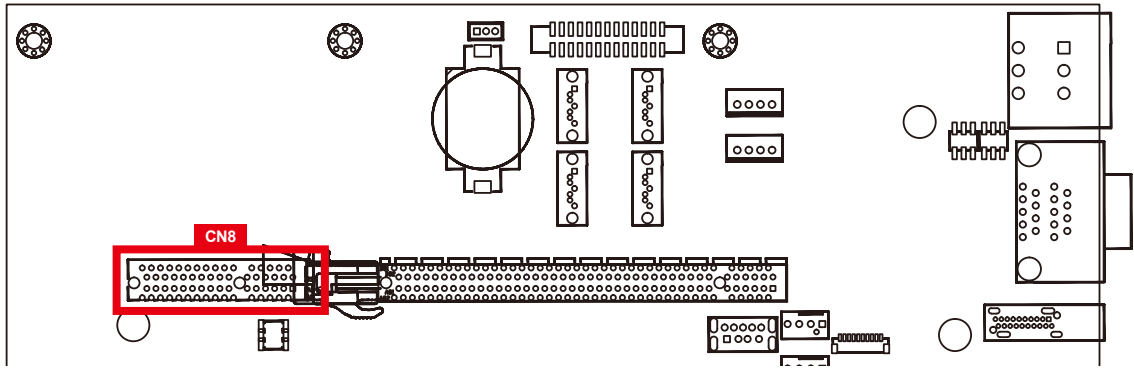

The pin assignments of CN8 are listed in the following table :

Pin No.	Function	Pin No.	Function
A1	Reserved	B1	+V12S
A2	+V12S	B2	+V12S
A3	+V12S	B3	+V12S
A4	GND	B4	GND
A5	CLKOUT_100M_X4_P9	B5	SM_SLOT_CLK
A6	CLKOUT_100M_X4_N9	B6	SM_SLOT_DAT
A7	CLKOUT_100M_X4_P10	B7	GND
A8	CLKOUT_100M_X4_N10	B8	+V3.3S
A9	+V3.3S	B9	Reserved
A10	+V3.3S	B10	+V3.3A
A11	PLTRST_PCIE#	B11	WAKE#
A12	GND	B12	Reserved
A13	CLKOUT_100M_X4_P0	B13	GND
A14	CLKOUT_100M_X4_N0	B14	PCIE_TXP9
A15	GND	B15	PCIE_TXN9
A16	PCIE_RXP9	B16	GND
A17	PCIE_RXN9	B17	Reserved
A18	GND	B18	GND
A19	Reserved	B19	PCIE_TXP10
A20	GND	B20	PCIE_TXN10
A21	PCIE_RXP10	B21	GND
A22	PCIE_RXN10	B22	GND
A23	GND	B23	PCIE_TXP11
A24	GND	B24	PCIE_TXN11
A25	PCIE_RXP11	B25	GND
A26	PCIE_RXN11	B26	GND
A27	GND	B27	PCIE_TXP12
A28	GND	B28	PCIE_TXN12
A29	PCIE_RXP12	B29	GND
A30	PCIE_RXN12	B30	CLKOUT_100M_X4_P1
A31	GND	B31	CLKOUT_100M_X4_N1
A32	Reserved	B32	GND

2.3.7 CN7 : PCIe x16 (CPU)

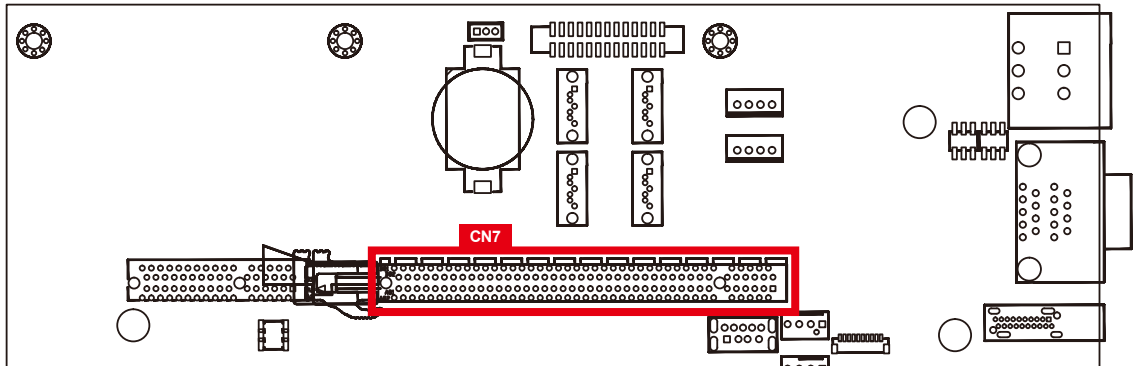

The pin assignments of CN7 are listed in the following table :

Pin No.	Function	Pin No.	Function
A1	Reserved	B1	+V12S
A2	+V12S	B2	+V12S
A3	+V12S	B3	+V12S
A4	GND	B4	GND
A5	CLKOUT_100M_X16_P5	B5	SM_SLOT_CLK
A6	CLKOUT_100M_X16_N5	B6	SM_SLOT_DAT
A7	USB_P14_DP	B7	GND
A8	USB_P14_DN	B8	+V3.3S
A9	+V3.3S	B9	GND
A10	+V3.3S	B10	+V3.3A
A11	PLTRST_PCIE#	B11	WAKE#
A12	GND	B12	Reserved
A13	CLKOUT_100M_X16_P4	B13	GND
A14	CLKOUT_100M_X16_N4	B14	PEG_TXP_0
A15	GND	B15	PEG_TXN_0
A16	PEG_RXP_0	B16	GND
A17	PEG_RXN_0	B17	Reserved
A18	GND	B18	GND
A19	Reserved	B19	PEG_TXP_1
A20	GND	B20	PEG_TXN_1
A21	PEG_RXP_1	B21	GND
A22	PEG_RXN_1	B22	GND
A23	GND	B23	PEG_TXP_2
A24	GND	B24	PEG_TXN_2
A25	PEG_RXP_2	B25	GND
A26	PEG_RXN_2	B26	GND
A27	GND	B27	PEG_TXP_3
A28	GND	B28	PEG_TXN_3
A29	PEG_RXP_3	B29	GND
A30	PEG_RXN_3	B30	PCIE_RXP19
A31	GND	B31	PCIE_RXN19
A32	CLKOUT_100M_X16_P3	B32	GND
A33	CLKOUT_100M_X16_N3	B33	PEG_TXP_4
A34	GND	B34	PEG_TXN_4

Pin No.	Function	Pin No.	Function
A35	PEG_RXP_4	B35	GND
A36	PEG_RXN_4	B36	GND
A37	GND	B37	PEG_TXP_5
A38	GND	B38	PEG_TXN_5
A39	PEG_RXP_5	B39	GND
A40	PEG_RXN_5	B40	GND
A41	GND	B41	PEG_TXP_6
A42	GND	B42	PEG_TXN_6
A43	PEG_RXP_6	B43	GND
A44	PEG_RXN_6	B44	GND
A45	GND	B45	PEG_TXP_7
A46	GND	B46	PEG_TXN_7
A47	PEG_RXP_7	B47	GND
A48	PEG_RXN_7	B48	Reserved
A49	GND	B49	GND
A50	Reserved	B50	PEG_TXP_8
A51	GND	B51	PEG_TXN_8
A52	PEG_RXP_8	B52	GND
A53	PEG_RXN_8	B53	GND
A54	GND	B54	PEG_TXP_9
A55	GND	B55	PEG_TXN_9
A56	PEG_RXP_9	B56	GND
A57	PEG_RXN_9	B57	GND
A58	GND	B58	PEG_TXP_10
A59	GND	B59	PEG_TXN_10
A60	PEG_RXP_10	B60	GND
A61	PEG_RXN_10	B61	GND
A62	GND	B62	PEG_TXP_11
A63	GND	B63	PEG_TXN_11
A64	PEG_RXP_11	B64	GND
A65	PEG_RXN_11	B65	GND
A66	GND	B66	PEG_TXP_12
A67	GND	B67	PEG_TXN_12
A68	PEG_RXP_12	B68	GND
A69	PEG_RXN_12	B69	GND
A70	GND	B70	PEG_TXP_13
A71	GND	B71	PEG_TXN_13
A72	PEG_RXP_13	B72	GND
A73	PEG_RXN_13	B73	GND
A74	GND	B74	PEG_TXP_14
A75	GND	B75	PEG_TXN_14
A76	PEG_RXP_14	B76	GND
A77	PEG_RXN_14	B77	GND
A78	GND	B78	PEG_TXP_15
A79	GND	B79	PEG_TXN_15
A80	PEG_RXP_15	B80	GND
A81	PEG_RXN_15	B81	PCIE_TXP19
A82	GND	B82	PCIE_TXN19

2.3.8 SATA1, SATA2, SATA3, SATA4 : SATA III Connector

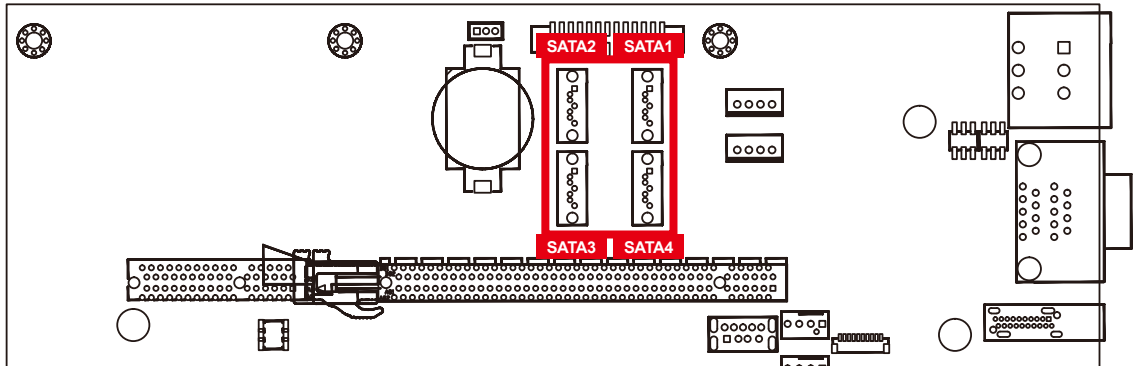

There are four onboard high performance Serial ATA III's (SATA III) on RCS-9000. It supports higher storage capacity with less cabling effort and smaller required space. The pin assignments of SATA1, SATA2, SATA3, and SATA4 are listed in the following table :

Pin No.	Definition	Pin No.	Definition
1	GND	5	RXN
2	TXP	6	RXP
3	TXN	7	GND
4	GND		

2.3.9 J1 : LPC Port 80 Debug Port

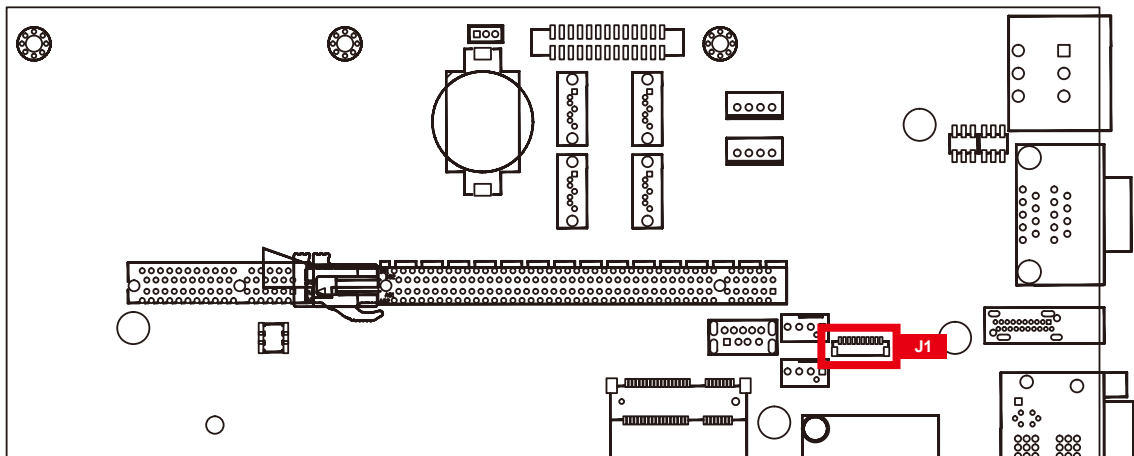

Pin No.	Definition	Pin No.	Definition
1	+V3.3S	6	LPC_AD3
2	LPC_SERIRQ	7	LPC_FRAME#
3	LPC_AD0	8	CLK_LPC_80
4	LPC_AD1	9	BUF_PLTRST_N_B
5	LPC_AD2	10	GND

2.3.10 CN20, CN36 : SATA Power Connector

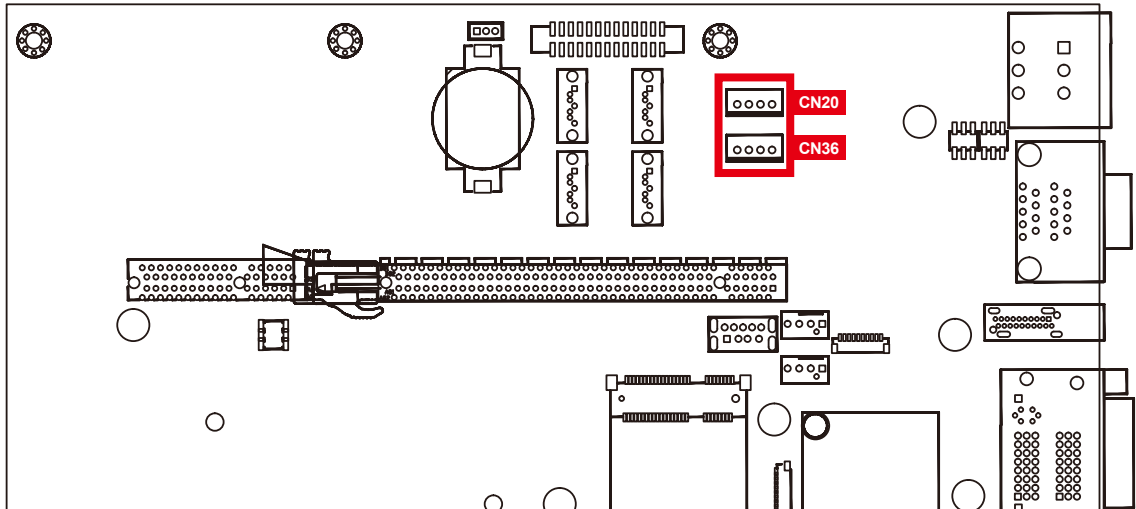

The RCS-9000 is also equipped with two SATA power connectors. It supports 5V (Up to 3A) and 12V (Up to 3A) currents to the hard drive or SSD. The pin assignments of CN20 and CN36 are listed in the following table :

Pin No.	Definition	Pin No.	Definition
1	+12V	3	GND
2	GND	4	+5V

2.3.11 CN15 : Internal Dual Port USB 3.0

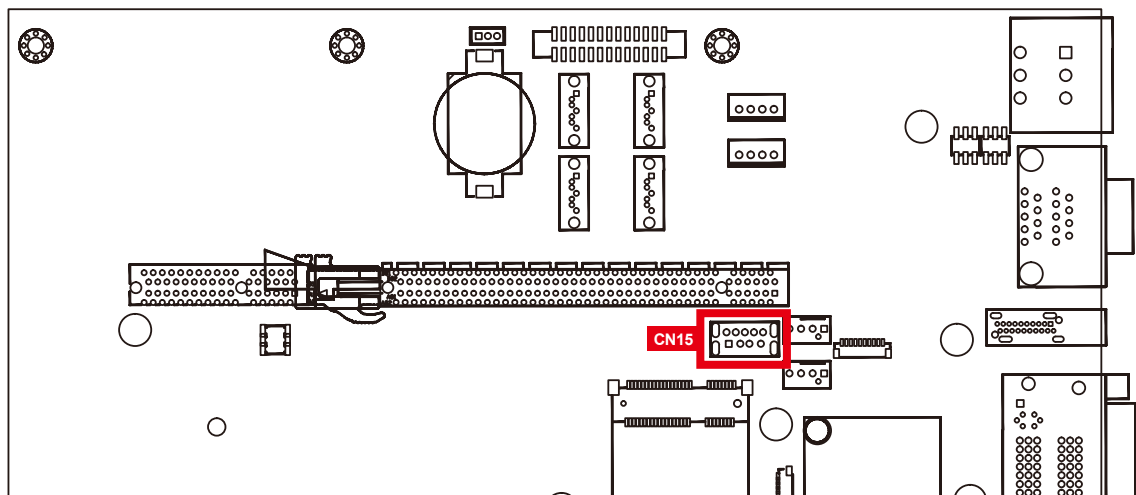

The RCS-9000 main board provides one expansion USB port using plug-and-play for Dongle Key or LCD touch panel. The USB interface supports 5G transfer rate which complies with high speed USB specification Rev. 3.0. The USB interface is accessed through one standard USB 3.0 connector. This USB 3.0 supports wake up function.

The pin assignments of CN15 are listed in the following table :

Pin No.	Definition	Pin No.	Definition
1	+V5_USB3_PWR5	6	USB_D_SSRX_5P
2	USB_D_4N	7	GND
3	USB_D_4P	8	USB_D_SSTX_5N
4	GND	9	USB_D_SSTX_5P
5	USB_D_SSRX_5N		

2.3.12 JUSB1 : Internal Dual Port USB 2.0

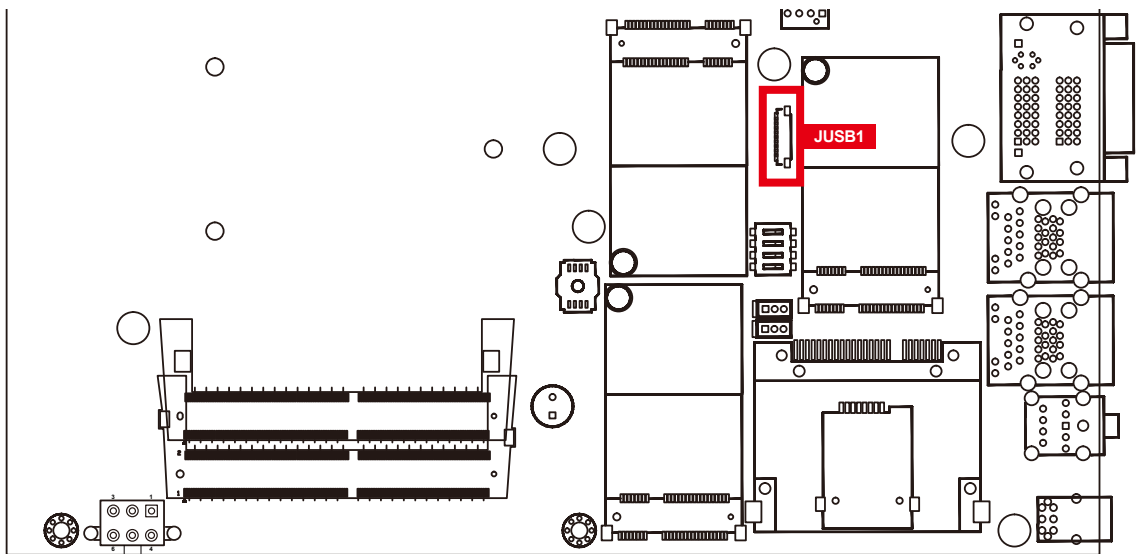

The RCS-9000 main board provides up to two expansion USB ports using plug-and-play for Dongle Key or LCD touch panel. The USB interface supports 480Mbps transfer rate which complies with high speed USB specification Rev. 2.0 and are fuse protected.

The USB interface is accessed through one 1x10-pin JST 1.0mm connector. You will need an adapter cable if you use a standard USB connector. The adapter cable has a 1x10-pin connector on one end and a USB connector on the other.

The pin assignments of JUSB1 are listed in the following table :

Pin No.	Definition	Pin No.	Definition
1	USB2_H1_PWR	6	USB_D_9N
2	USB2_H1_PWR	7	USB_D_9P
3	USB2_H1_PWR	8	GND
4	USB_D_7N	9	GND
5	USB_D_7P	10	GND

2.3.13 MPCIE1 : Mini PCIe, mSATA

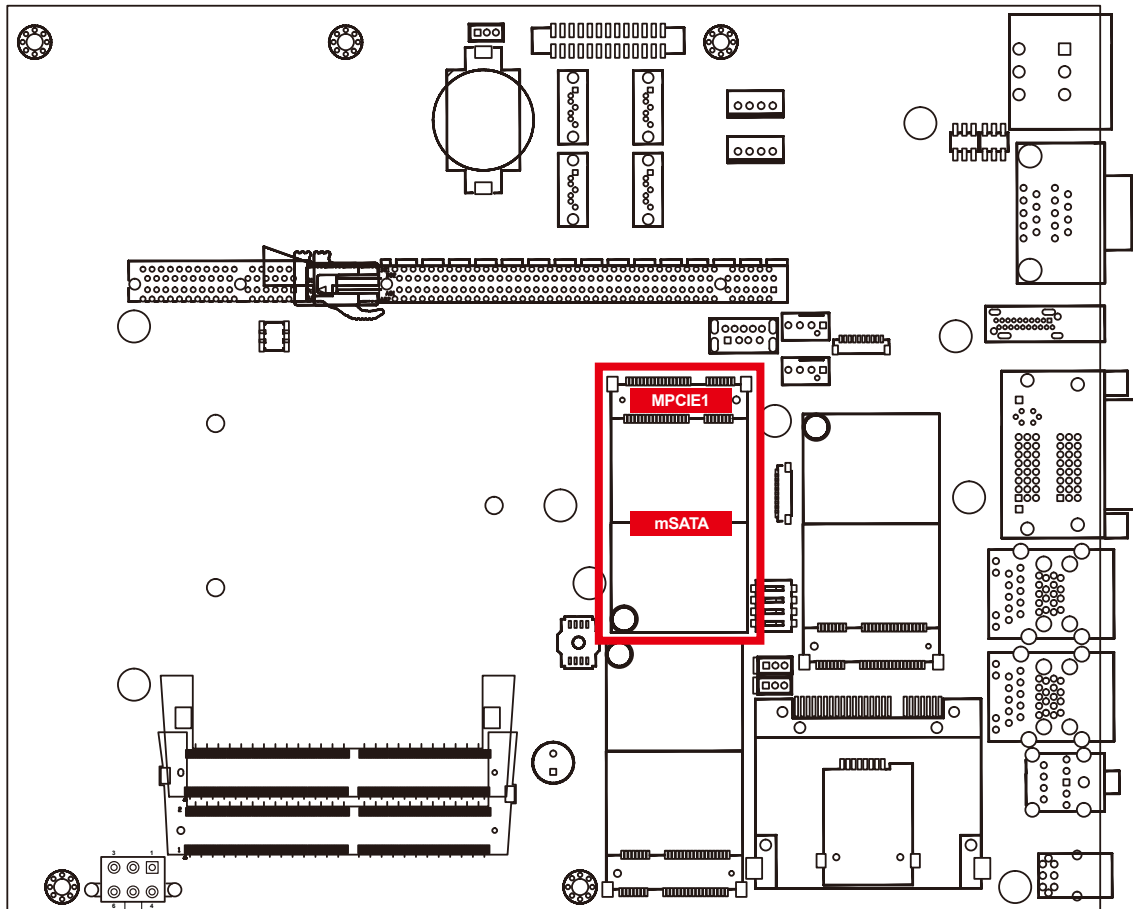

Both mSATA and mini PCIe share the same form factor and similar electrical pinout assignments on their connectors. There was no clear mechanism to distinguish if an mSATA drive or a Mini PCIe device is plugged into the socket until recently that SATA I/O issued an ECN change (ECN #045) to redefine pin-43 on mSATA connector as "no connect" instead of "return current path" (or GND).

When an mSATA drive is inserted, its pin-43 is "no connect", and the respective pin on the socket is being pulled-up to logic 1. When a mini PCIe device is inserted, its pin-43 forces the respective pin on the socket to ground, or logic 0.

The pin assignments of MPCIE1 are listed in the following table :

Pin No.	function	Pin No.	function
51	Reserved	52	+3.3Vaux
49	Reserved	50	GND
47	Reserved	48	+1.5V
45	Reserved	46	Reserved
43	Status	44	Reserved
41	+3.3Vaux	42	Reserved
39	+3.3Vaux	40	GND
37	GND	38	USB_D+
35	GND	36	USB_D-
33	PETp0	34	GND
31	PETn0	32	SMB_DATA
29	GND	30	SMB_CLK
27	GND	28	+1.5V
25	PERp0	26	GND
23	PERn0	24	+3.3Vaux
21	GND	22	PERST#
19	Reserved	20	reserved
17	Reserved	18	GND
Mechanical Key			
15	GND	16	Reserved
13	REFCLK+	14	Reserved
11	REFCLK-	12	Reserved
9	GND	10	Reserved
7	CLKREQ#	8	Reserved
5	Reserved	6	1.5V
3	Reserved	4	GND
1	WAKE#	2	3.3Vaux

2.3.14 MPCIE2, MPCIE3 : Mini PCIe

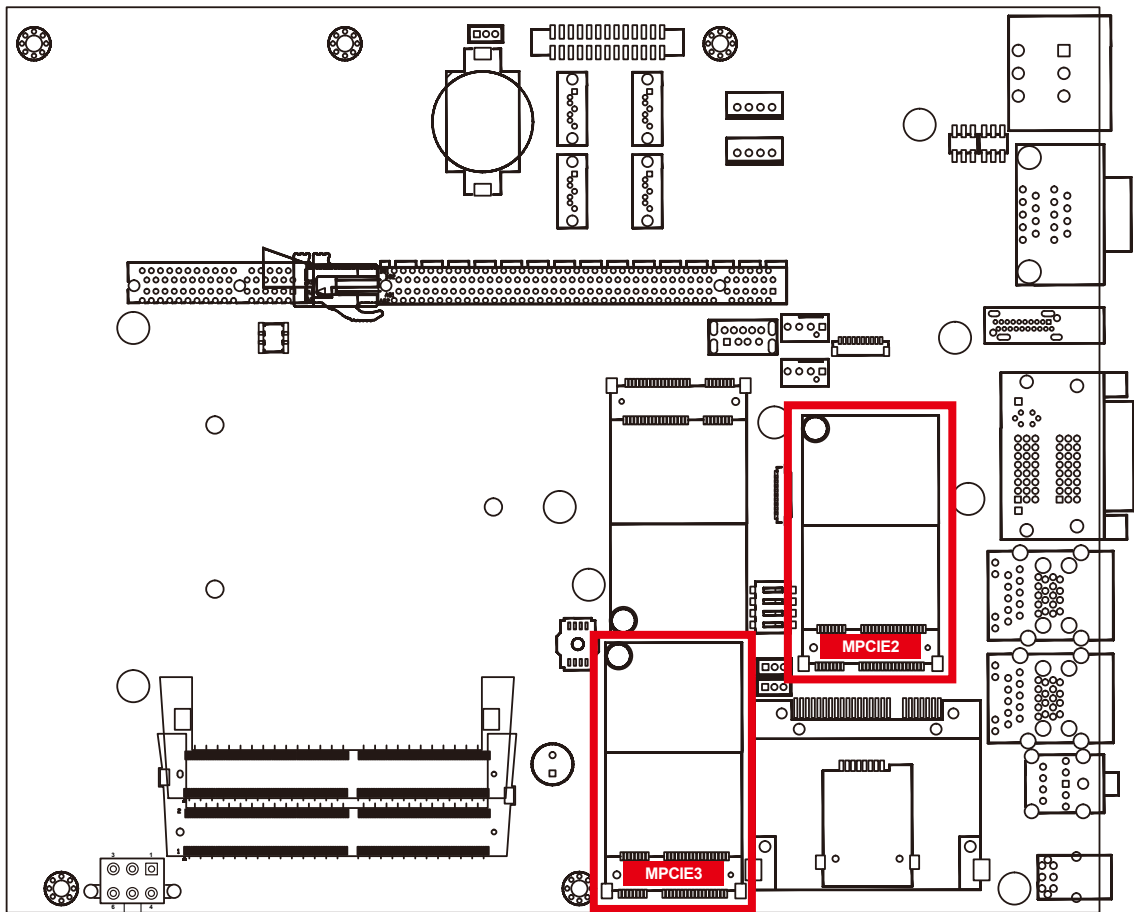

The pin assignments of MPCIE2 and MPCIE3 are listed in the following table :

Pin No.	function	Pin No.	function
51	Reserved	52	+3.3Vaux
49	Reserved	50	GND
47	Reserved	48	+1.5V
45	Reserved	46	Reserved
43	GND	44	Reserved
41	+3.3Vaux	42	Reserved
39	+3.3Vaux	40	GND

37	GND	38	USB_D+
35	GND	36	USB_D-
33	PETp0	34	GND
31	PETn0	32	SMB_DATA
29	GND	30	SMB_CLK
27	GND	28	+1.5V
25	PERp0	26	GND
23	PERn0	24	+3.3Vaux
21	GND	22	PERST#
19	Reserved	20	reserved
17	Reserved	18	GND
Mechanical Key			
15	GND	16	Reserved
13	REFCLK+	14	Reserved
11	REFCLK-	12	Reserved
9	GND	10	Reserved
7	CLKREQ#	8	Reserved
5	Reserved	6	1.5V
3	Reserved	4	GND
1	WAKE#	2	3.3Vaux

2.3.15 CN9 : CFAST

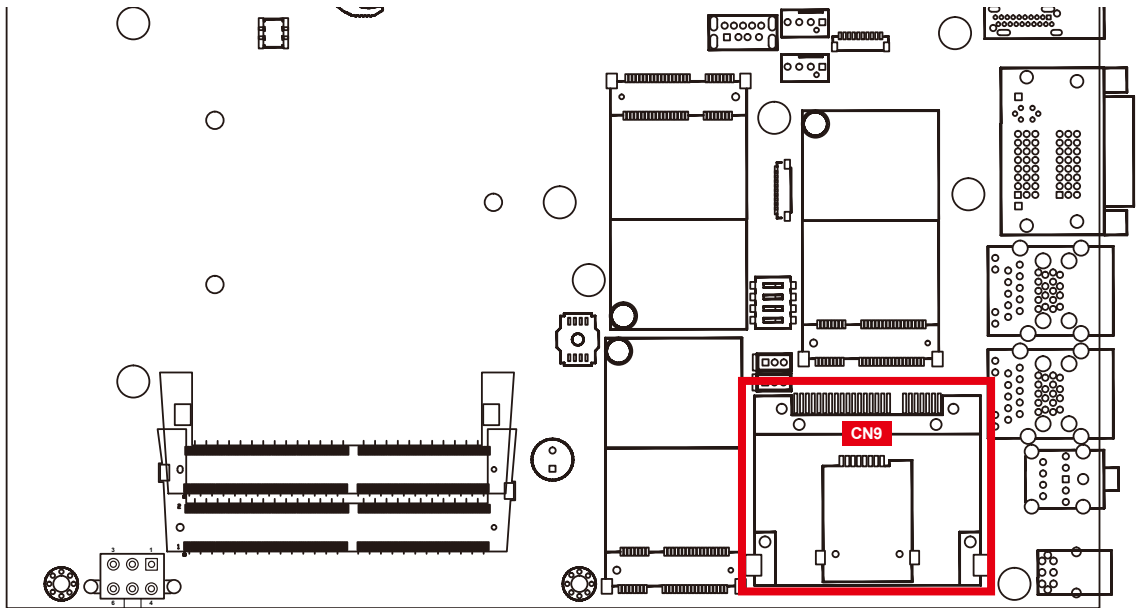

The RCS-9000 system comes with a CFAST socket on the front panel for Type-I/ Type-II compact flash card. It is implemented by a SATA III Port from C236 PCH. Be sure to disconnect the power source and unscrew the CFAST socket cover before installing a CFAST card. The RCS-9000 does not support the CFAST hot swap and PnP (plug-and-play) functions. It is necessary to remove the power source first before inserting or removing the CFAST card. The following table shows the pinouts for CFAST port :

Pin No.	Definition	Pin No.	Definition
S1	GND	PC6	Reserved
S2	SATA_TX4	PC7	GND
S3	SATA_TX#4	PC8	CFAST_LED
S4	GND	PC9	Reserved
S5	SATA_RX#4	PC10	Reserved
S6	SATA_RX4	PC11	Reserved
S7	GND	PC12	Reserved
PC1	GND	PC13	+V3.3S
PC2	GND	PC14	+V3.3S
PC3	Reserved	PC15	GND
PC4	Reserved	PC16	GND
PC5	Reserved	PC17	Reserved

2.3.16 CN16 : IO Board Connector

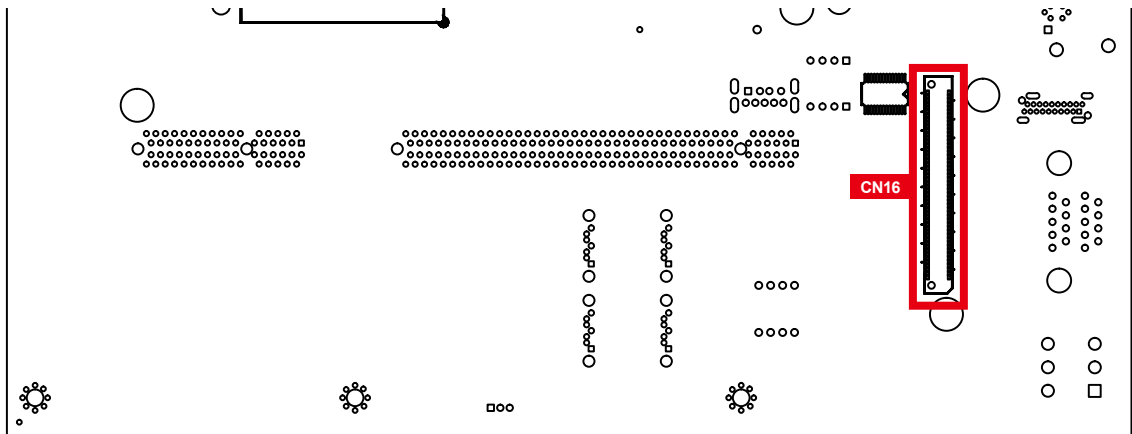

The pin assignments of CN16 are listed in the following table :

Pin No.	Function	Pin No.	Function
1	UIM_PWR_2	2	UIM_PWR_3
3	UIM_DATA_2	4	UIM_DATA_3
5	UIM_CLK_2	6	UIM_CLK_3
7	UIM_RESET_2	8	UIM_RESET_3
9	UIM_VPP_2	10	UIM_VPP_3
11	SIO_GPI80	12	DIO2_GPI0
13	SIO_GPI81	14	DIO2_GPI1
15	SIO_GPI82	16	DIO2_GPI2
17	SIO_GPI83	18	DIO2_GPI3
19	SIO_GPI84	20	DIO2_GPI4
21	SIO_GPI85	22	DIO2_GPI5
23	SIO_GPI86	24	DIO2_GPI6
25	SIO_GPI87	26	DIO2_GPI7
27	SIO_GPO70	28	DIO2_GPO0
29	SIO_GPO71	30	DIO2_GPO1
31	SIO_GPO72	32	DIO2_GPO2
33	SIO_GPO73	34	DIO2_GPO3
35	SIO_GPO74	36	DIO2_GPO4
37	SIO_GPO75	38	DIO2_GPO5
39	SIO_GPO76	40	DIO2_GPO6
41	SIO_GPO77	42	DIO2_GPO7
43	GND	44	GND
45	UART3_DCD#	46	UART4_DCD#
47	UART3_RXD	48	UART4_RXD
49	UART3_TXD	50	UART4_TXD
51	UART3_DTR#	52	UART4_DTR#

53	UART3_DSR#	54	UART4_DSR#
55	UART3_RTS#	56	UART4_RTS#
57	UART3_CTS#	58	UART4_CTS#
59	UART3_RI#	60	UART4_RI#
61	UART3_MODE0	62	UART4_MODE0
63	UART3_MODE1	64	UART4_MODE1
65	UART3_MODE2	66	UART4_MODE2
67	SP338E_TERM_COM3	68	SP338E_TERM_COM4
69	+V3.3S	70	+V3.3S
71	+V3.3S	72	+V3.3S
73	GND	74	GND
75	PCIE_TXP20	76	PCIE_RXP20
77	PCIE_TXN20	78	PCIE_RXN20
79	GND	80	GND
81	USB3_P10_RX_DN	82	USB3_P8_RX_DN
83	USB3_P10_RX_DP	84	USB3_P8_RX_DP
85	GND	86	GND
87	USB3_P10_TX_DN	88	USB3_P8_TX_DN
89	USB3_P10_TX_DP	90	USB3_P8_TX_DP
91	GND	92	GND
93	USB_P10_DP	94	USB_P8_DP
95	USB_P10_DN	96	USB_P8_DN
97	+V5A	98	+V5A
99	+V5A	100	+V5A

2.3.17 CN39 : 6pin Power Connector

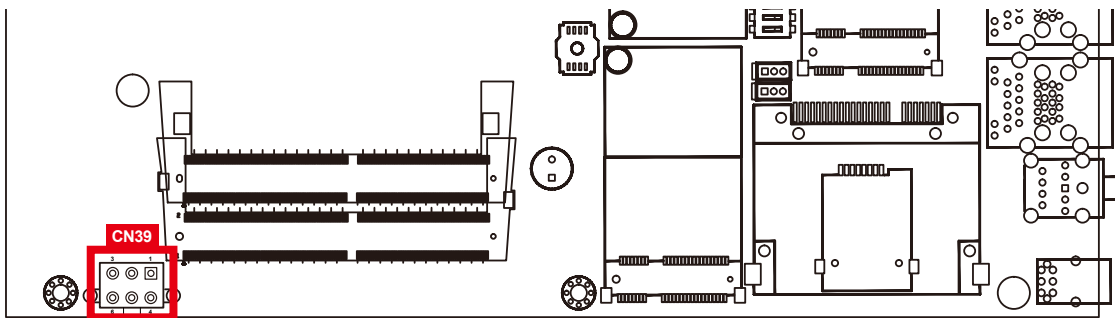

Pin No.	Function	Pin No.	Function
1	VCC (+V12)	4	GND
2	VCC (+V12)	5	GND
3	VCC (+V12)	6	GND

2.4 Main Board Jumper Settings

You may configure your card to match the needs of your application by setting jumpers. A jumper is a metal bridge used to close an electric circuit. It consists of two metal pins and a small metal clip (often protected by a plastic cover) that slides over the pins to connect them. To "close" a jumper, you connect the pins to the clip. To "open" a jumper, you remove the clip. Sometimes a jumper will have three pins, labeled 1, 2, and 3. In this case you would connect either pins 1 and 2 or 2 and 3. The figure below is the top view of the RCS-9000 main board. It shows the location of the jumpers.

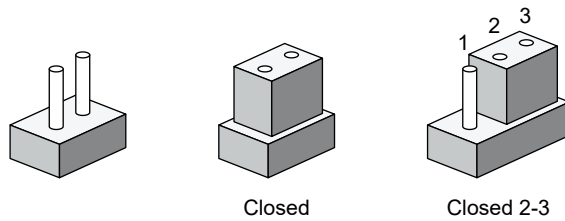

2.4.1 Front View of RCS-9000 Main Board With Jumper Location

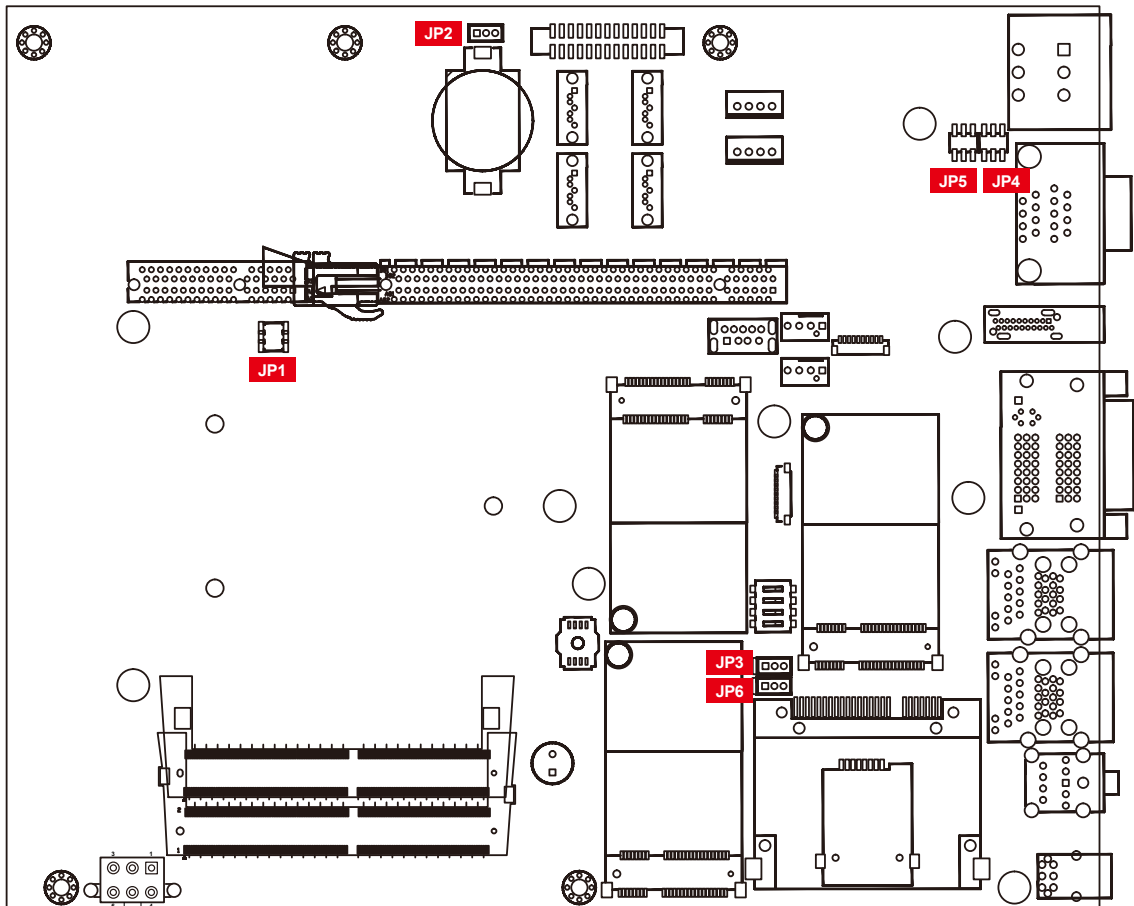

2.4.2 JP4, JP5

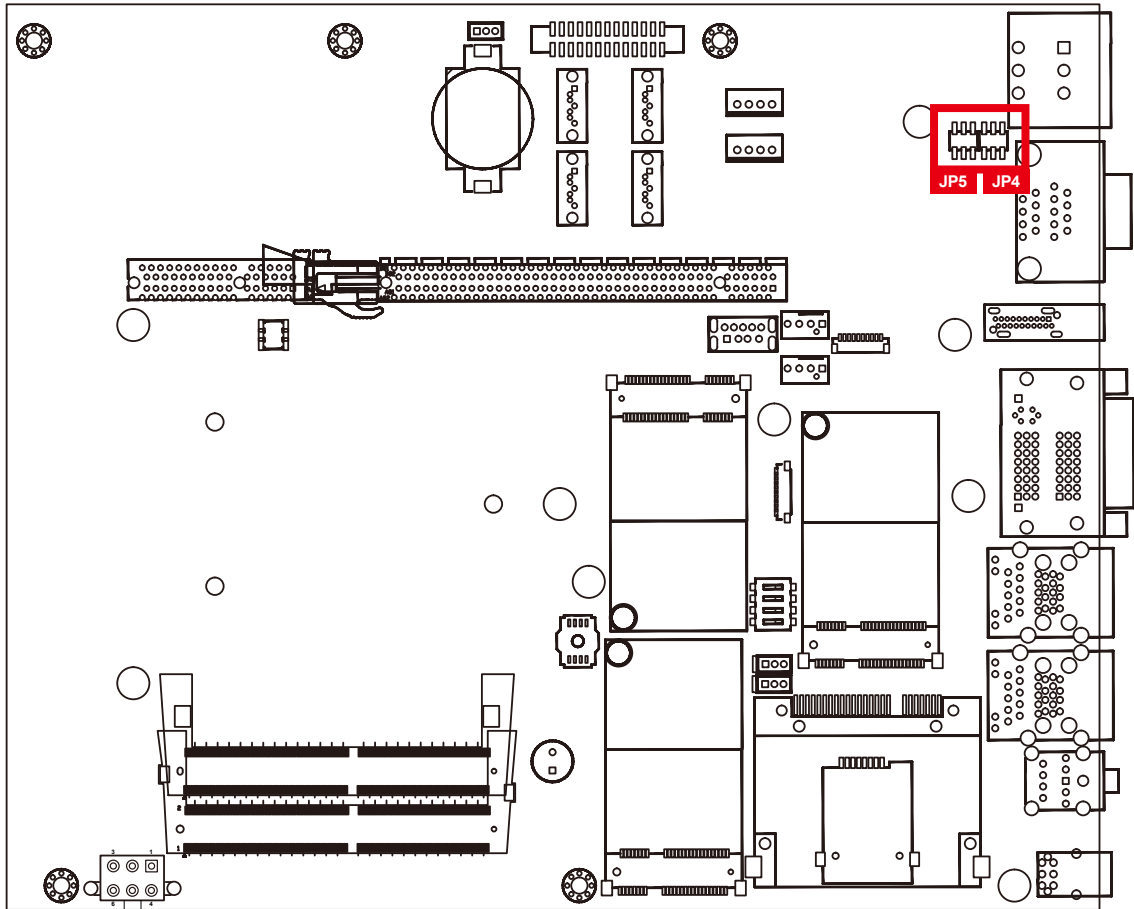

Pin Header	Pin No.	Description
COM1 JP4	1-2	+5V (1A max.)
	3-4	+12V (0.5A max.)
	5-6	RI (Default)

Pin Header	Pin No.	Description
COM2 JP5	1-2	+5V (1A max.)
	3-4	+12V (0.5A max.)
	5-6	RI (Default)

2.4.3 JP1 : CPU PCIe x 16 (CN8) Configuration

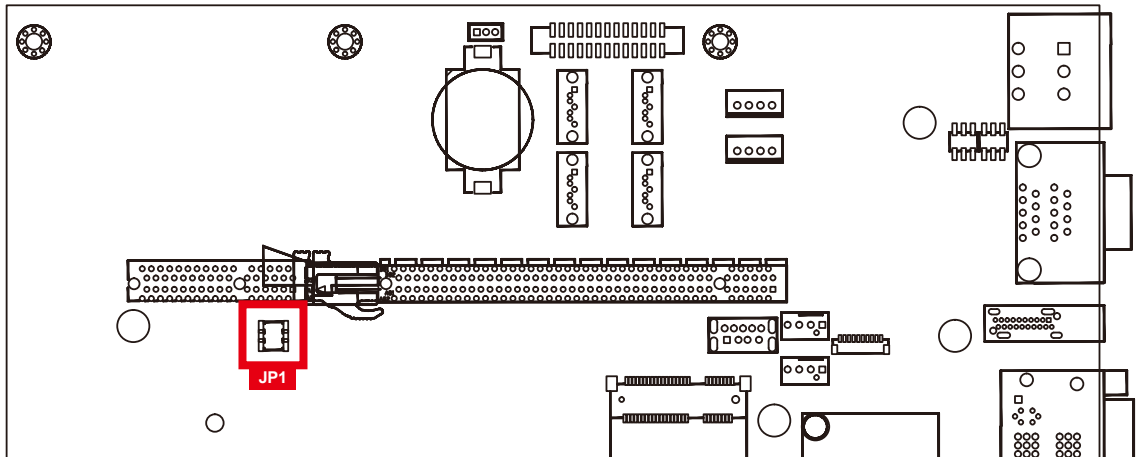

CPU PCIe x 16 (CN8) configuration table as follows :

Pin Header	Pin No.	PCIe Configuration
JP1	(3-5) (4-6)	1 x 8, 2 x 4
	(3-5) (2-4)	2 x 8
	(1-3) (2-4)	1 x16

2.4.4 JP2 : Clear CMOS

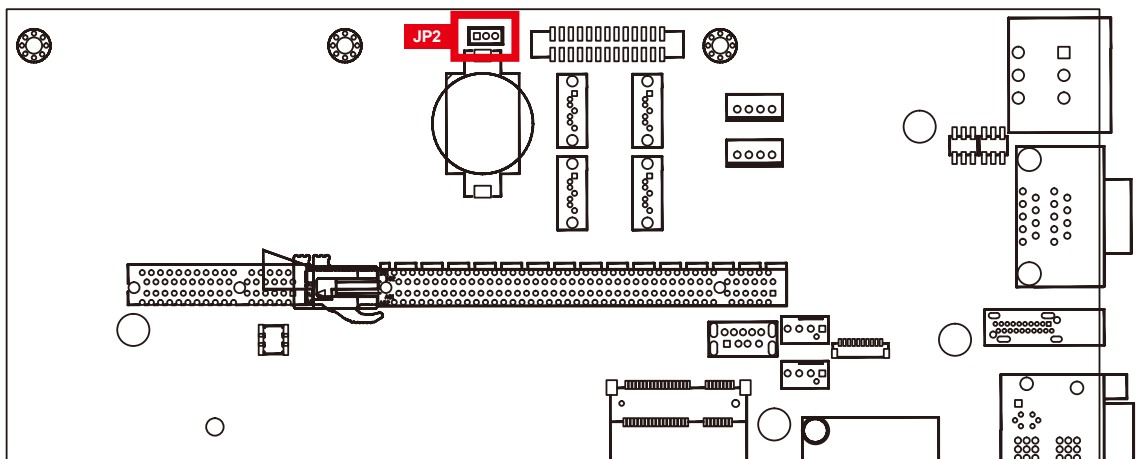

Pin Header	Pin No.	Description
JP2	1-2	Normal (Default)
	2-3	Clear CMOS

2.4.5 JP6 : USB Wake Up

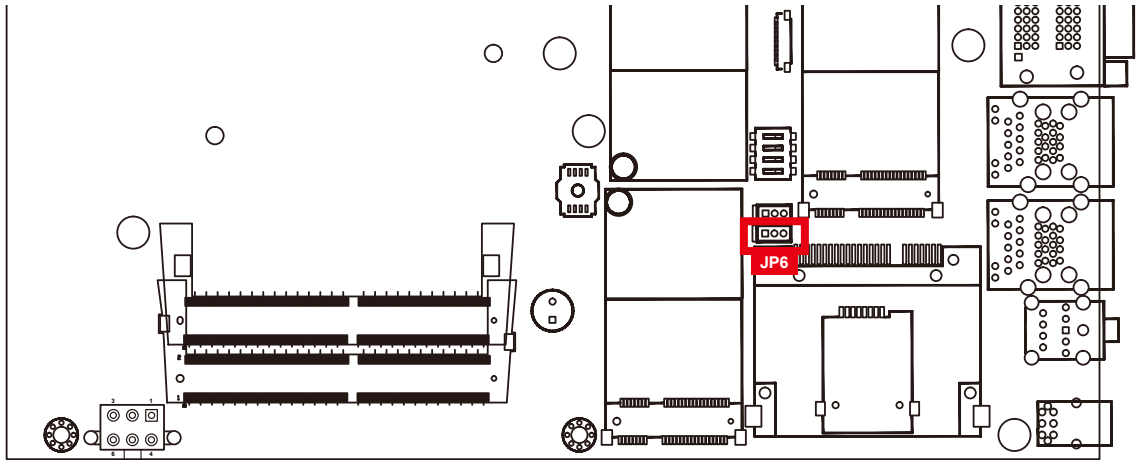

Pin Header	Pin No.	Definition
JP6	2-3	USB 3.0 and USB 2.0 Wake Up Disable
	1-2	USB 3.0 and USB 2.0 Wake Up Enable (Default)

2.4.6 JP3

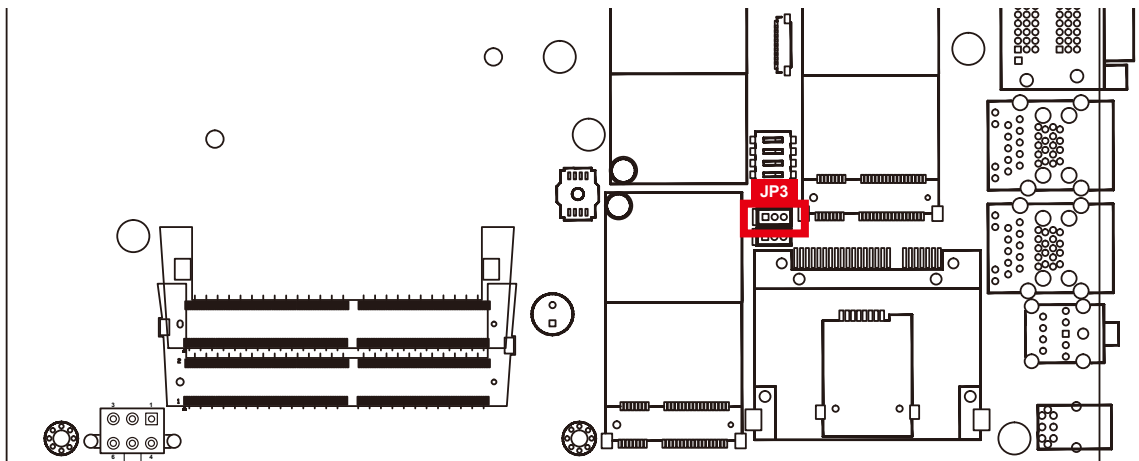

Pin Header	Pin No.	Definition
JP3	2-3	Disable Flash Descriptor Security (override)
	1-2	Enable security measures defined in the Flash Descriptor. (Default)

2.5 Ignition Control

2.5.1 SW1 : Ignition Control



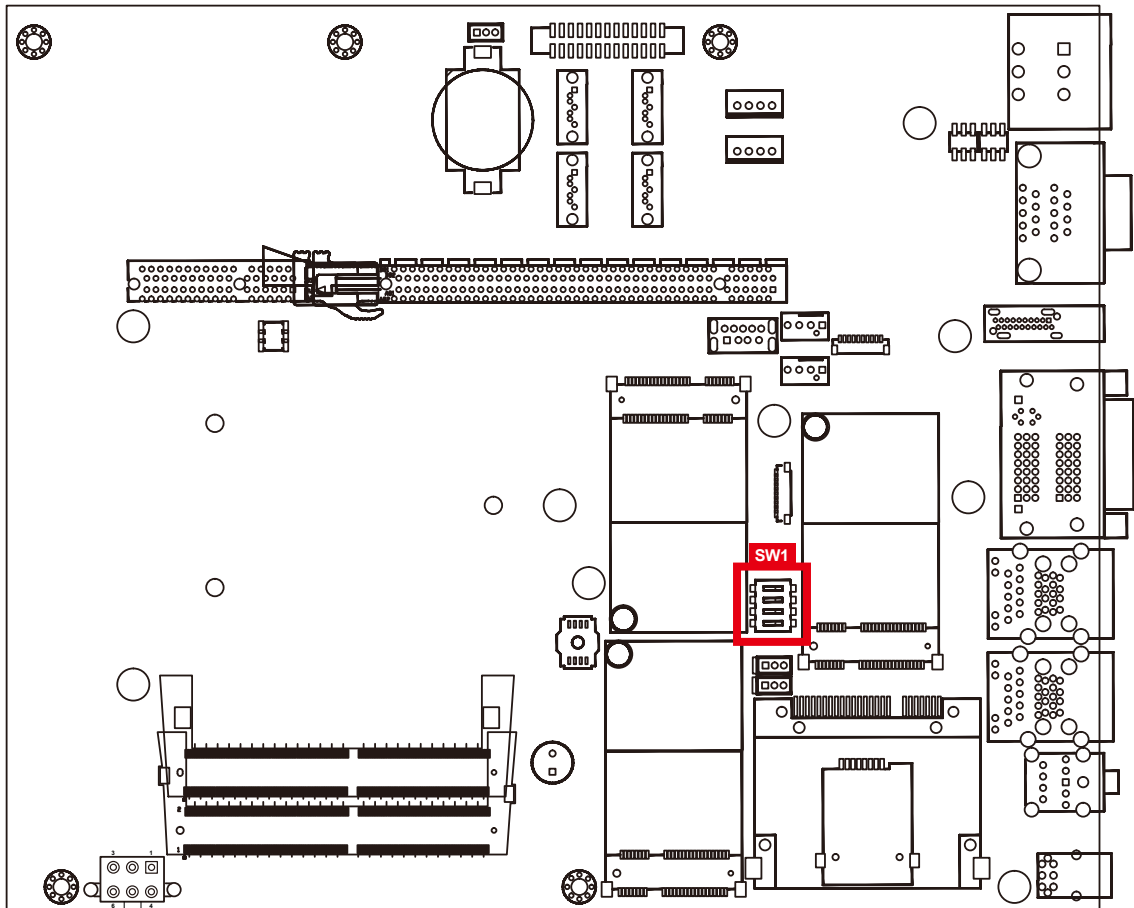







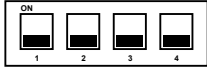





The RCS-9000 series provide ignition power control feature for in-vehicle applications. The built-in MCU monitors the ignition signal and turns on/off the system according to pre-defined on/off delay period.



2.5.2 Adjust Ignition Control Modes

The RCS-9000 series provide sixteen modes of different power on/off delay periods adjustable via rotary switch. The default rotary switch is set to 0 in ATX/AT power mode.

The modes are listed in the following table :

DIP-Switch Position	Power on delay	Power off delay	Switch Position
0	ATX/AT mode		
1	No delay	No delay	
2	No delay	5 seconds	
3	No delay	10 seconds	
4	No delay	20 seconds	
5	5 seconds	30 seconds	
6	5 seconds	60 seconds	
7	5 seconds	90 seconds	
8	5 seconds	30 minutes	
9	5 seconds	1 hour	
A	10 seconds	2 hours	
B	10 seconds	4 hours	
C	10 seconds	6 hours	
D	10 seconds	8 hours	
E	10 seconds	12 hours	
F	10 seconds	24 hours	

2.5.3 Ignition Control Wiring

To activate ignition control, you need to provide IGN signal via the 3-pin plugable terminal block located on the front panel. Please use the following pictures to find the general wiring configuration.

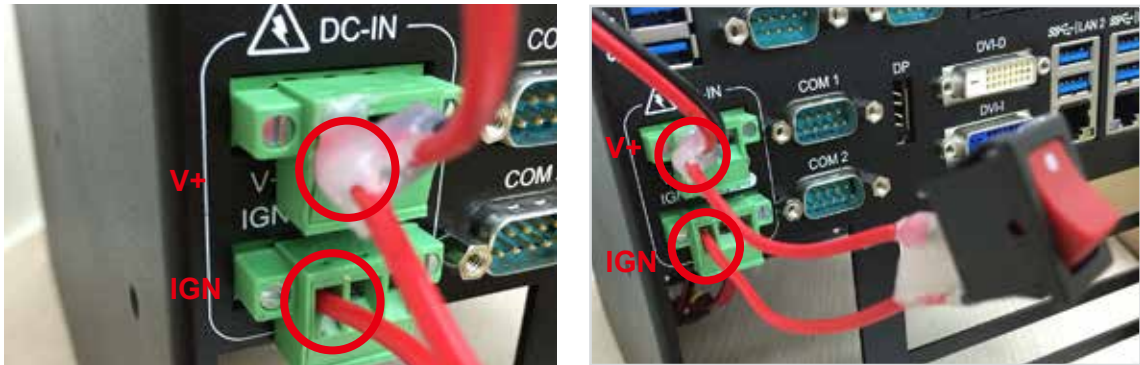

V+ : Positive polarity of DC power input (Car battery+ for 12/24/36V)

V- : Ground of DC power input (Car battery -/GND line to GND)

IGN : Ignition signal input (ACC power of vehicle)

For testing purpose, you can refer to the picture above to simulate ignition signal input controlled by a latching switch.

Note :

1. DC power source and IGN share the same ground.
2. RCS-9000 supports 6V~36V wide range DC power input in ATX/AT mode. In Ignition mode, the input voltage is fixed to 12V/24V for car battery scenario.
3. For proper ignition control, the power button setting should be "Power down" mode.

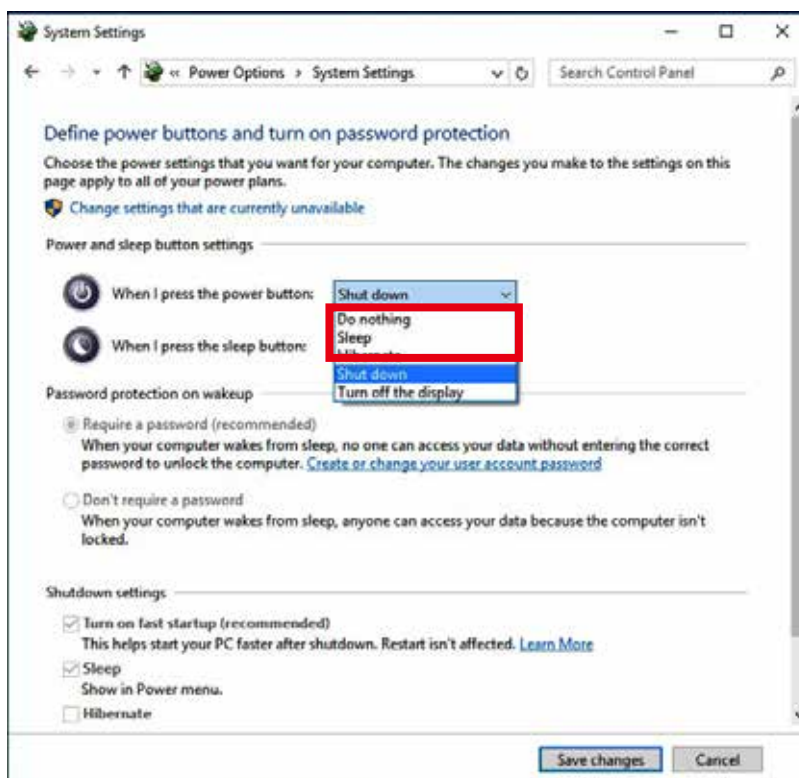

In Windows, for example, you need to set "When I press the power button" to "Shut down."

3

SYSTEM SETUP

3.1 How to Open Your RCS-9000F GTX1080

Step 1 Remove two F-6-32x6 screws (circled in red) and five F-M3x4 screws (circled in yellow) on the top cover.



Take off the top cover



Step 2 Remove ATX power cable on MB and GTX-1080.

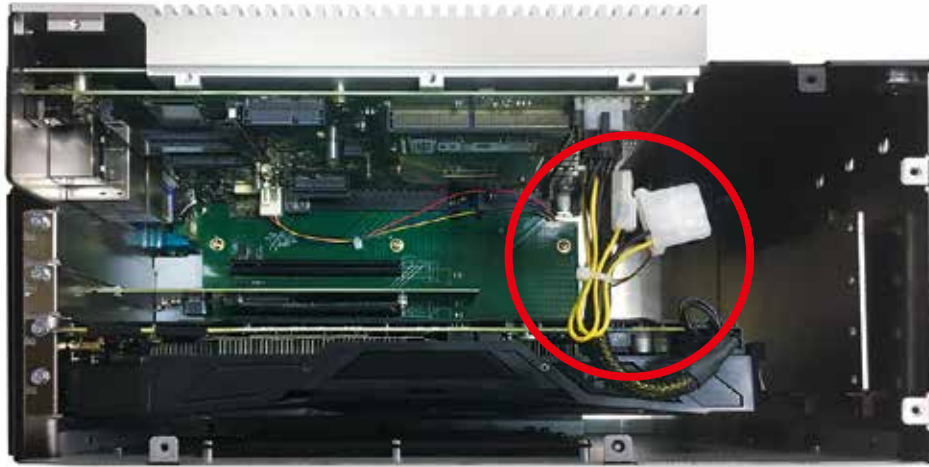

Take off the top cover.



Step 3 Remove two M3x5L screws.

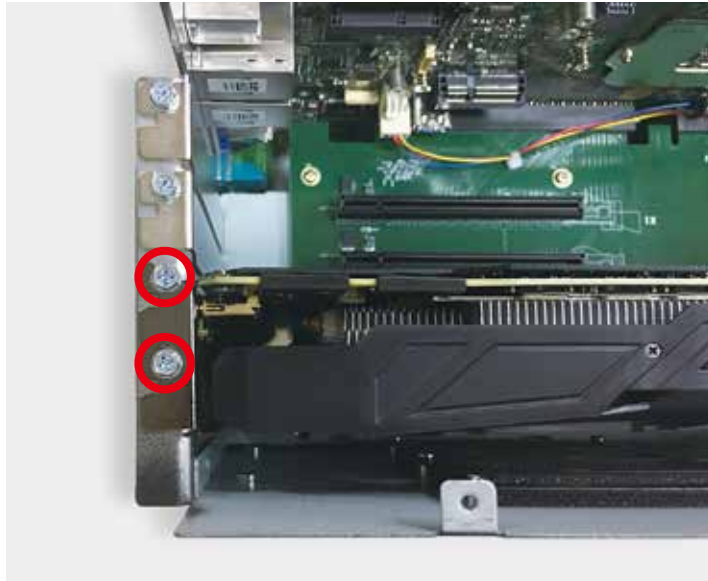

Push down the PCIe x16 slot lock and remove GTX-1080.

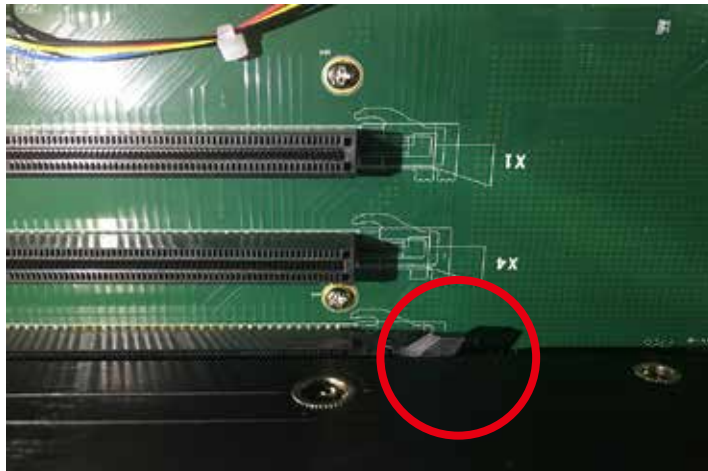

Step 4 Remove five F-M3x4 screws on the bottom cover.



Remove two F-M3x4 screws on the front.



Remove three F-M3x4 screws on the rear.



Take off the bottom cover.



Step 5 Remove riser card PH-M3 screws (circle in red), FAN cable (circle in yellow) and take off the riser card.

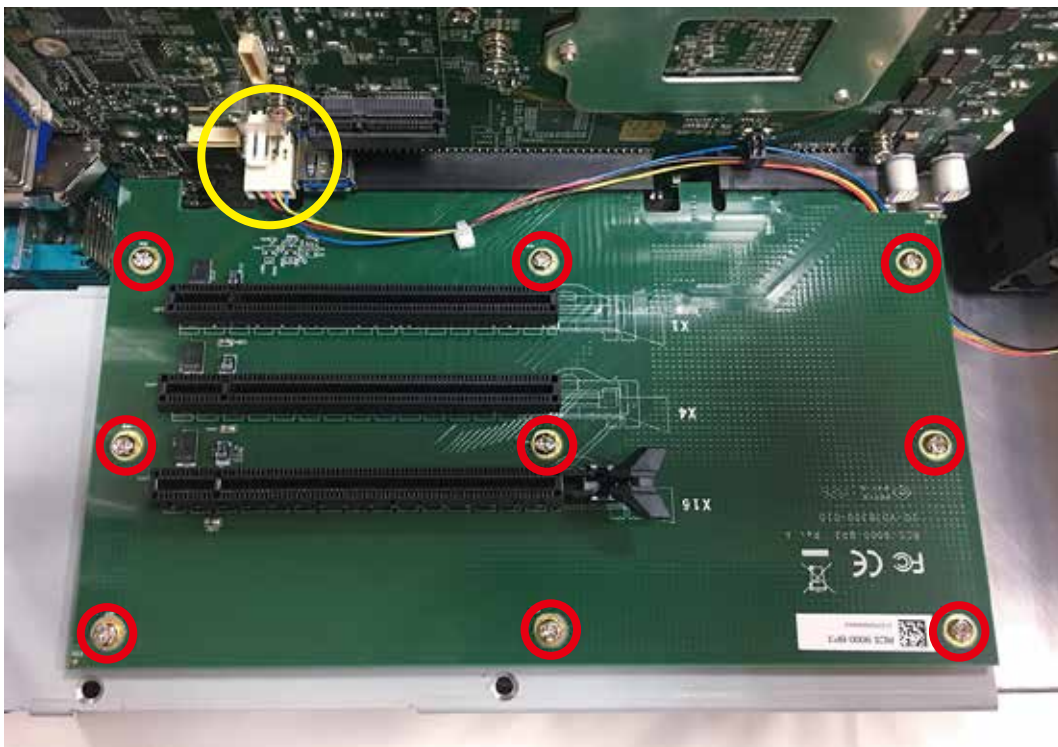
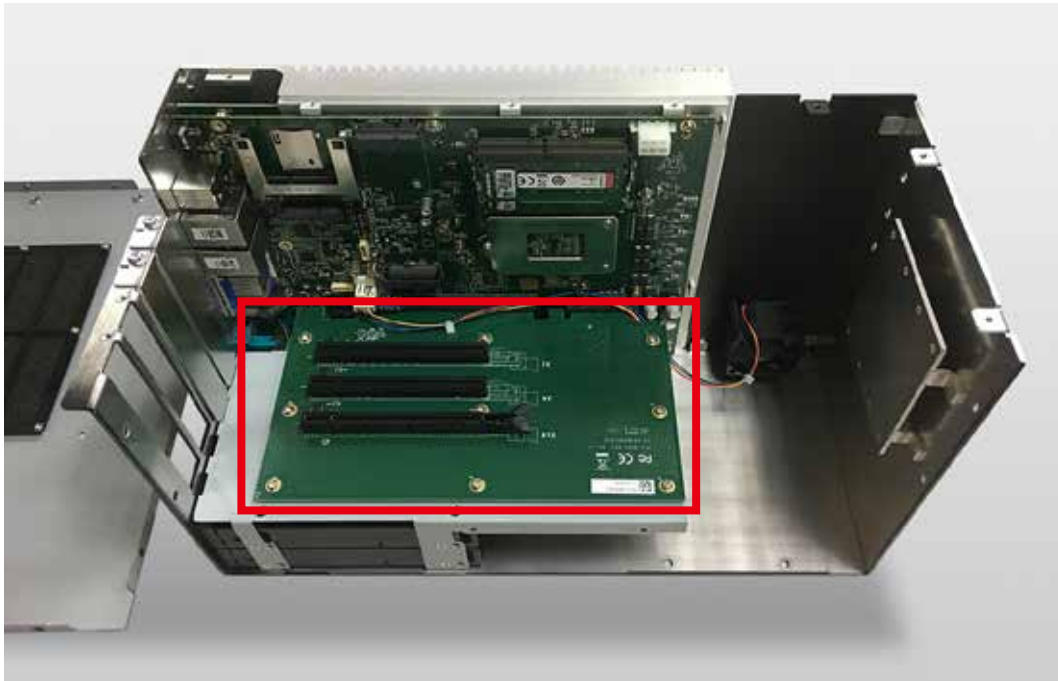

Step 6 Remove com ports eight #4-40 (red) and one KHS-632x8 (yellow) screw on the front panel.



Remove four F-632x6 screws.

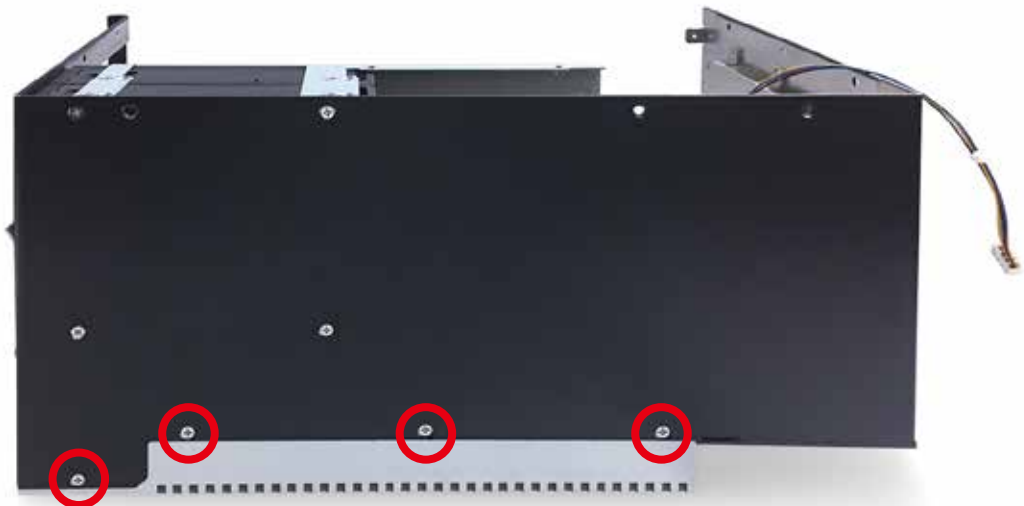

Step 7 Take off the front panel sequence 1~3.



Sequence 1.



Sequence 2.



Sequence 3.



Step 8 Take off the SATA cable.

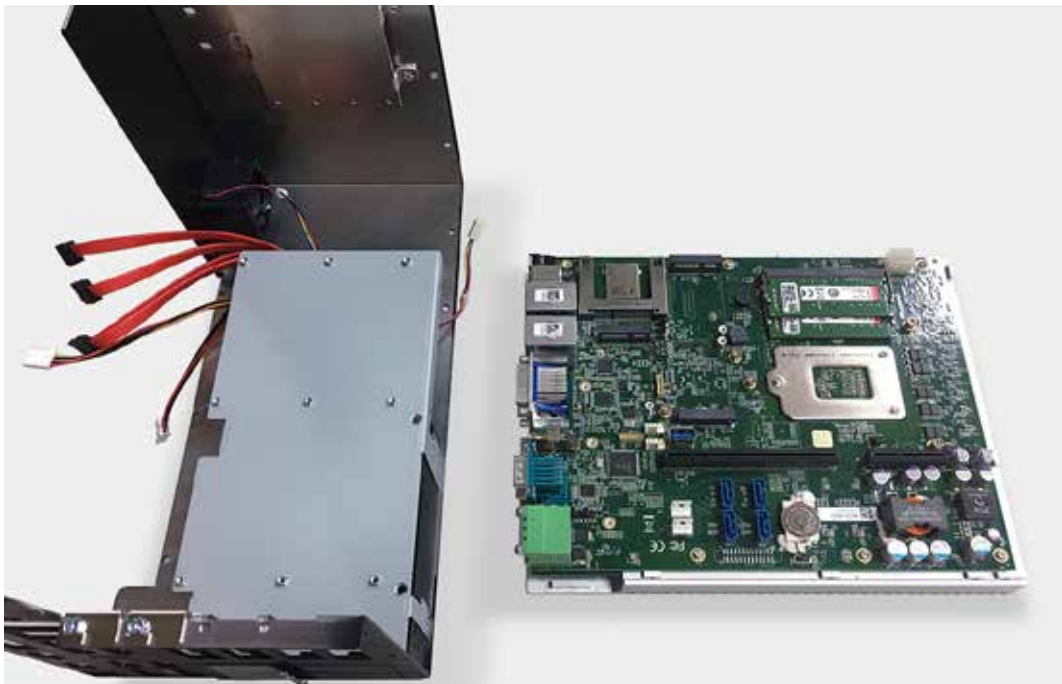

3.2 Installing CPU

Step 1 Remove five M3x11 Spring screws (red) and five PH M3x6L screws (yellow).

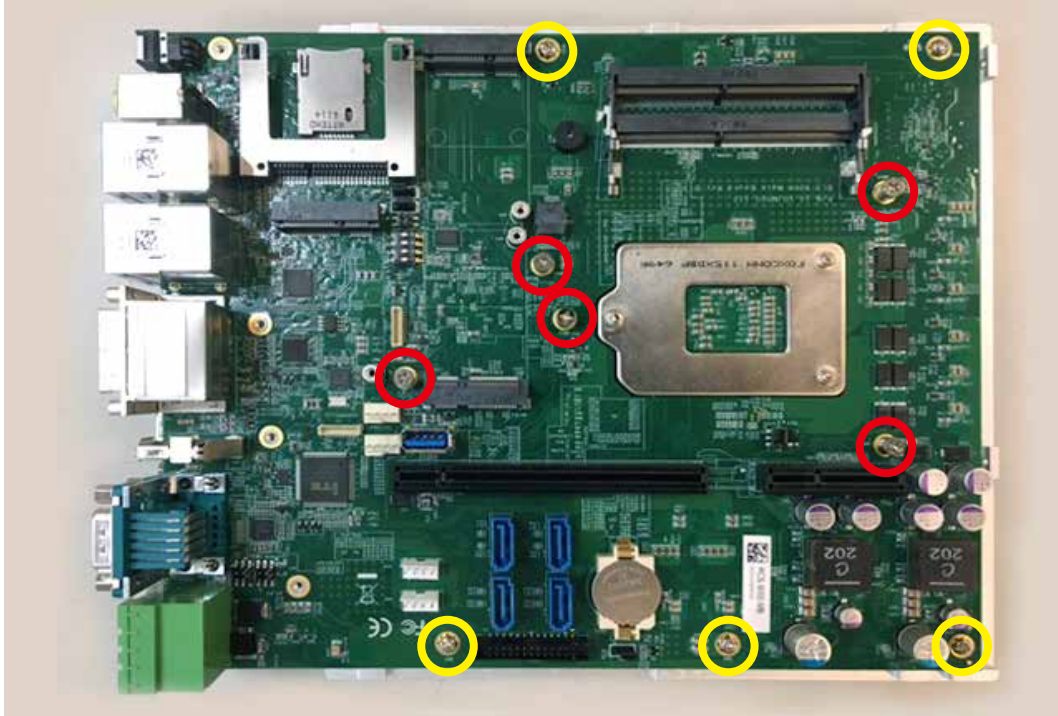

Step 2 Open the CPU slot.

Step 3 Push the slot key.

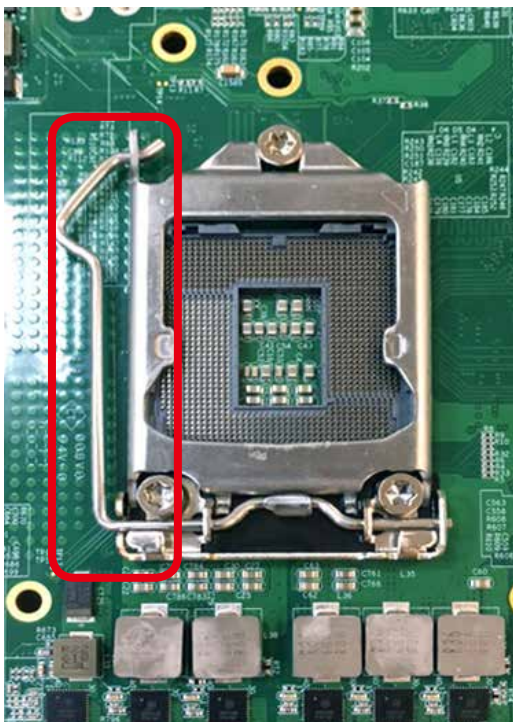

Step 4 Check CPU and CPU slot lock pin.



Step 5 Close the slot key.



Step 6 Make sure the key is in the screw.



3.3 Installing DDR4 SO-DIMM Modules

Step 1 Install DDR4 RAM module into SO-DIMM slot.



Step 2 Make sure the RAM module is locked by the memory slot (red).



3.4 Installing Mini PCIe Card

Step 1 Install Mini PCIe card into the Mini PCIe slot.



Step 2 Fasten one M2.5 screw.



3.5 Installing Antenna Cable

Step 1 Check antenna cable and washers.



Step 2 Remove one rubber cork from the rear panel. (pick the location you want).



Step 3 Fasten washer 1, washer 2, and washer 3 on Antenna cable connector.



Step 4 Antenna cable installation is finished.



3.6 Installing CFast Card

Step 1 Open the top cover so you can see the CFast slot.

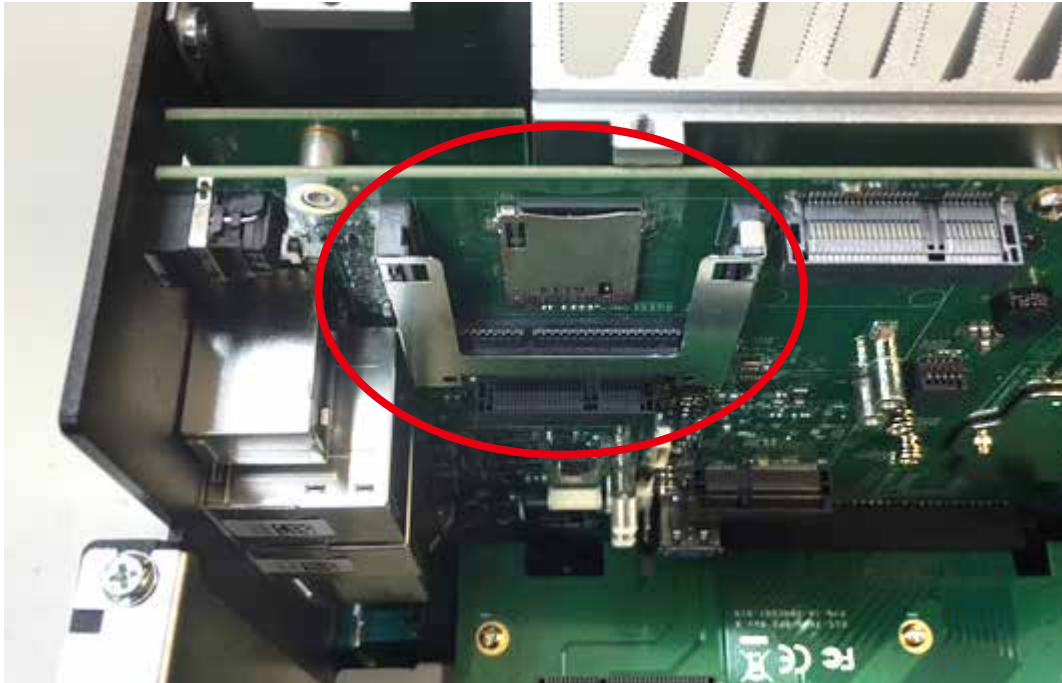

Step 2 Install the CFast card in the slot.

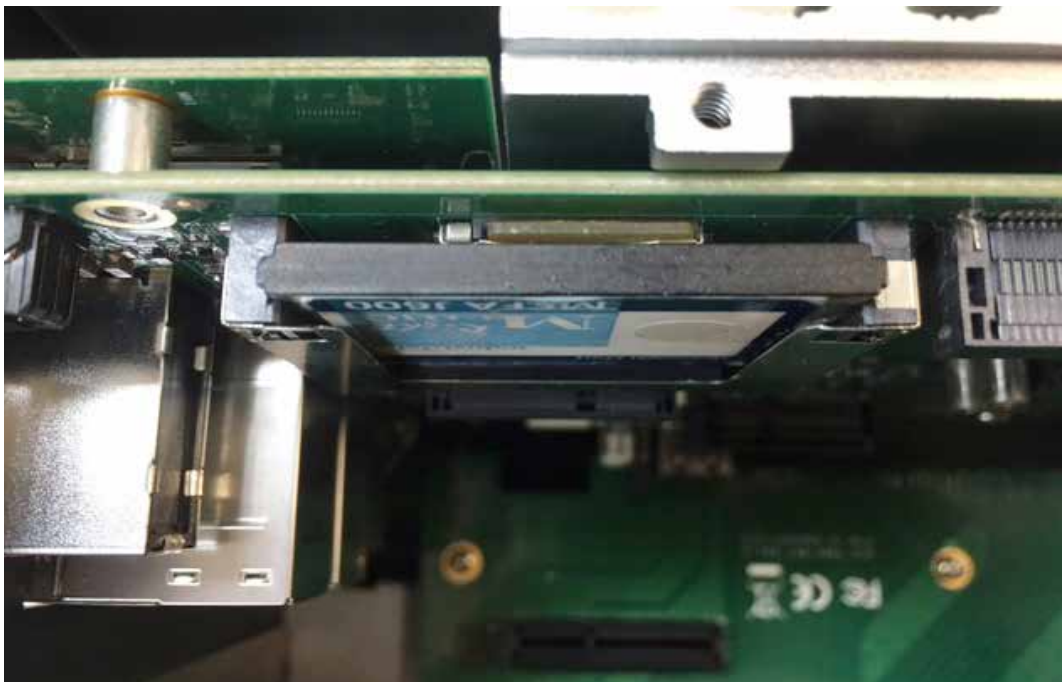

3.7 Installing SIM Card

3.7.1 External SIM Card

Step 1 Remove SIM cover.



Step 2 Install SIM card in the marked red area.



Step 3 Finish.



3.7.2 Internal SIM Card

Step 1 Open the top cover so you can see the SIM slot.



Step 2 Finish.



3.8 Installing PCI/PCIe Card

RCS-94xxF series : supports the full length 312mm (without card bracket) of PCI/PCIe expansion card.

Step 1 Open the top cover so you can see the PCI/PCIe slot.

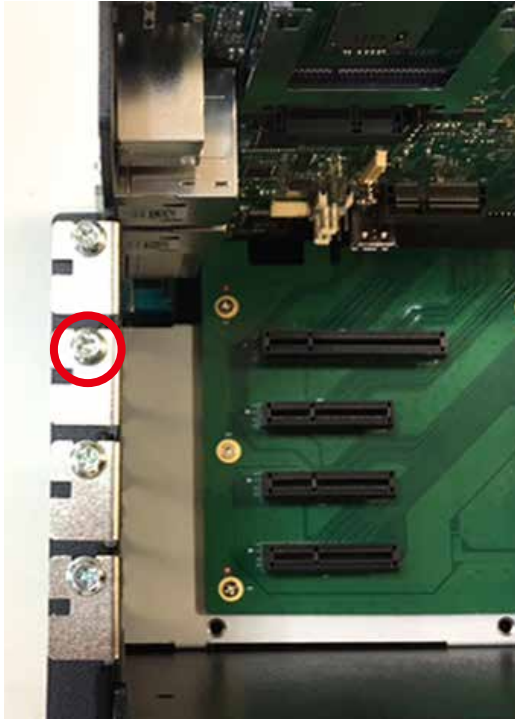

Step 2 Remove M3x5L screws and PCI bracket.



Step 3 Install the PCI/PCIe Card and lock it in place.

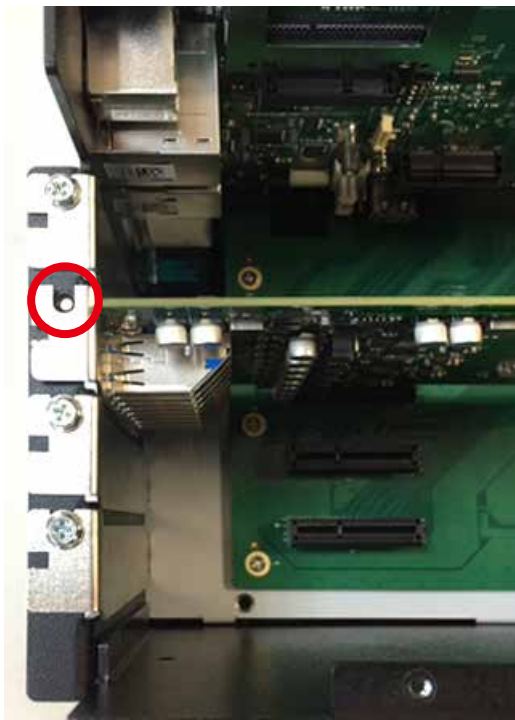

Step 4 Finish.

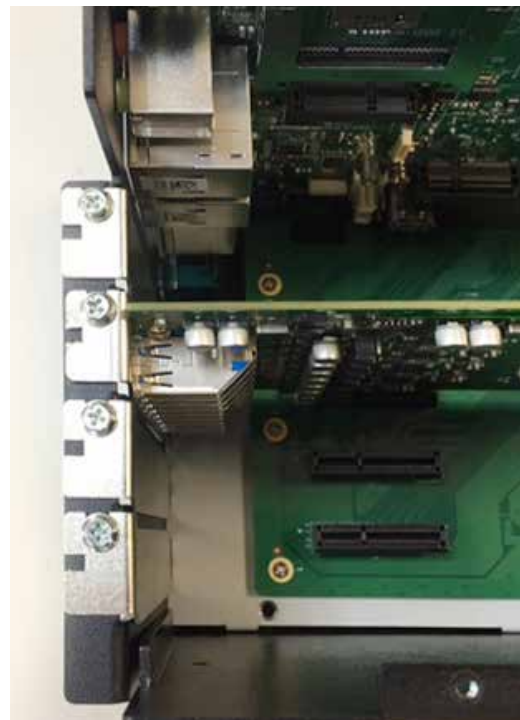

3.9 Installing SSD/HDD

3.9.1 External SSD/HDD (For RCS-9430FR/9430FHR/9421FR/9421FHR/9412FR/9412FHR-GTX1080)

Step 1 Trigger and open SSD/HDD tray.



Step 2 Insert 2.5" SSD/HDD into the tray.



Step 3 Push back and close the SSD/HDD tray.



Step 4 Lock the SSD/HDD tray with the key.



3.9.2 Internal SSD/HDD (For RCS-9430F/9430FH/9421F/9421FH/9412F/9412FH-GTX1080)

Step 1 Repeat 3.1 steps one through seven.

Step 2 Remove four F-M3x4 screws (red).

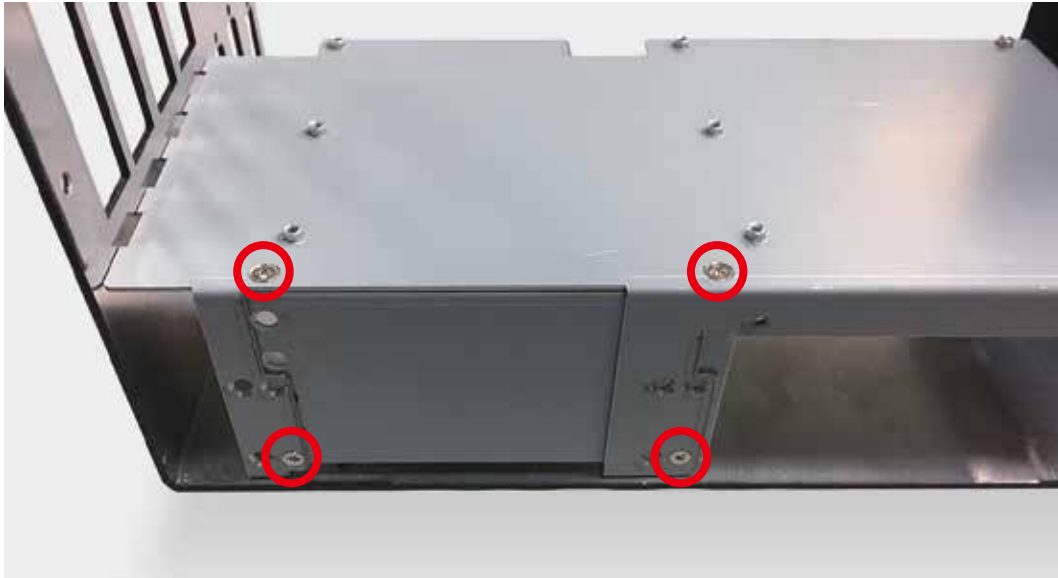

Step 3 Install SSD/HDD with bracket.



Loch the SSD/HDD with bracket in F-M3x4L (one SSD with four F-M3x4L).



3.10 Mounting Your RCS-9000F GTX1080

Step 1 Take the RCS-9000 wallmount.



Step 2 Install wall mount to RCS-9000 bottom.



Step 3 Install four F-632x6L screws.



4

BIOS AND DRIVER SETTING

4.1 BIOS Settings

BIOS provides an interface for users to check and change system configuration. The BIOS setup program is accessed by pressing the key when POST display output is shown.

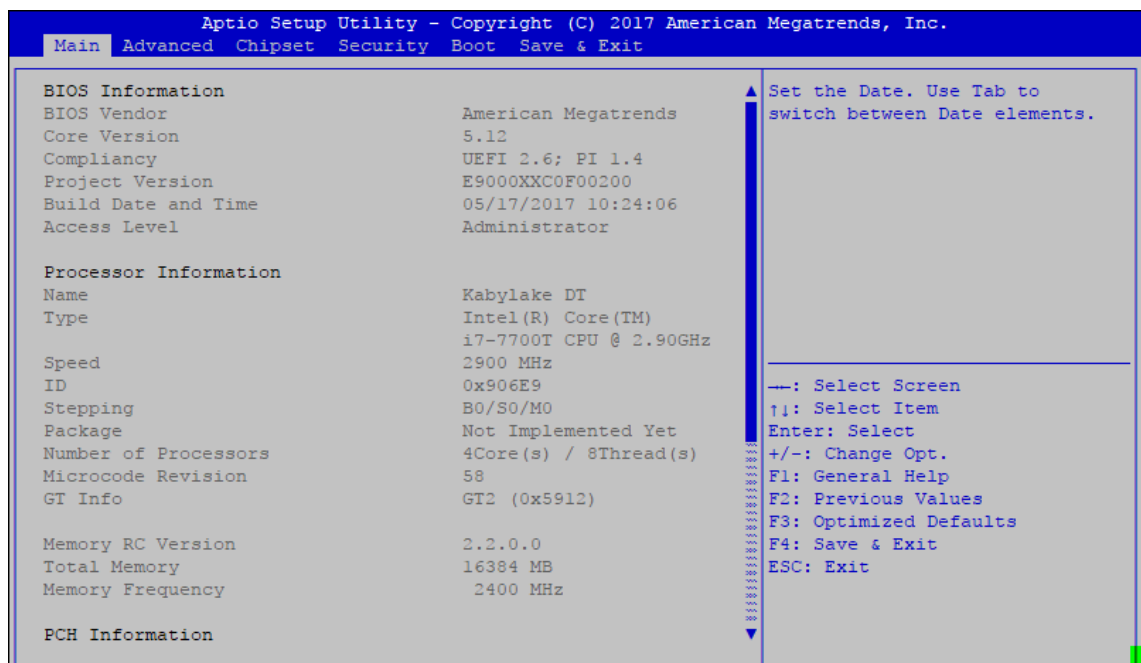

Figure 4-1 : Entering Setup Screen

4.2 Main Menu

The main menu displays BIOS version and system information. There are two options on Main menu.

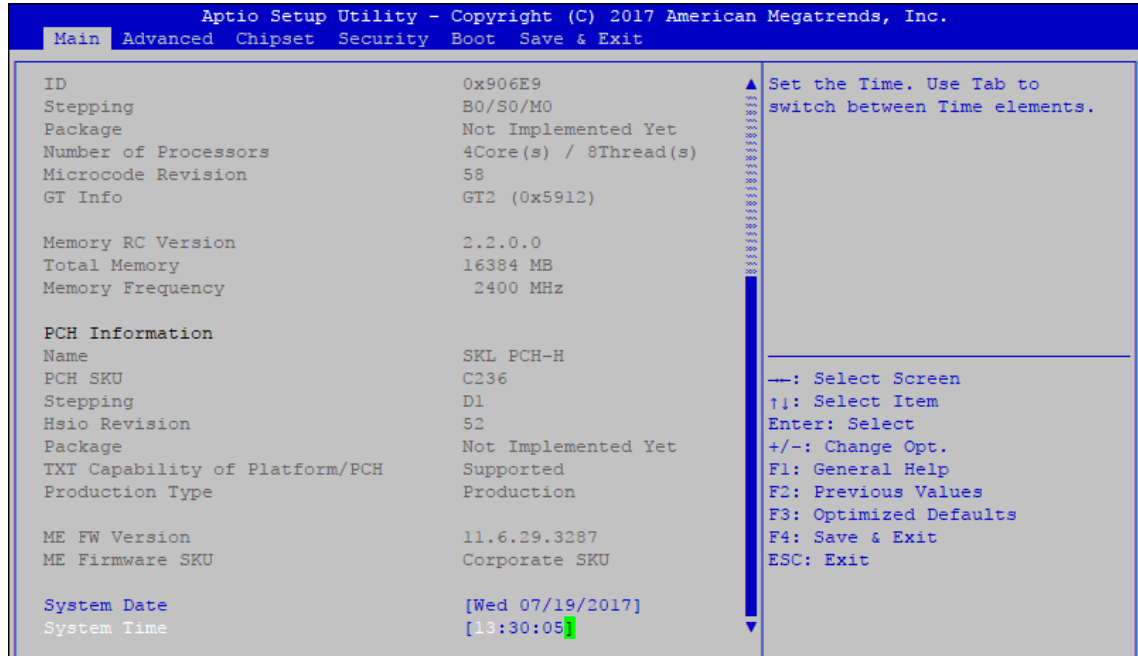

Figure 4-2 : BIOS Main Menu

System Date

Set the date. Use <Tab> to switch between date elements.

System Time

Set the time. Use <Tab> to switch between time elements.

4.3 Advanced Function

Select advanced tab to enter advanced BIOS setup options, such as CPU configuration, SATA configuration, and USB configuration.

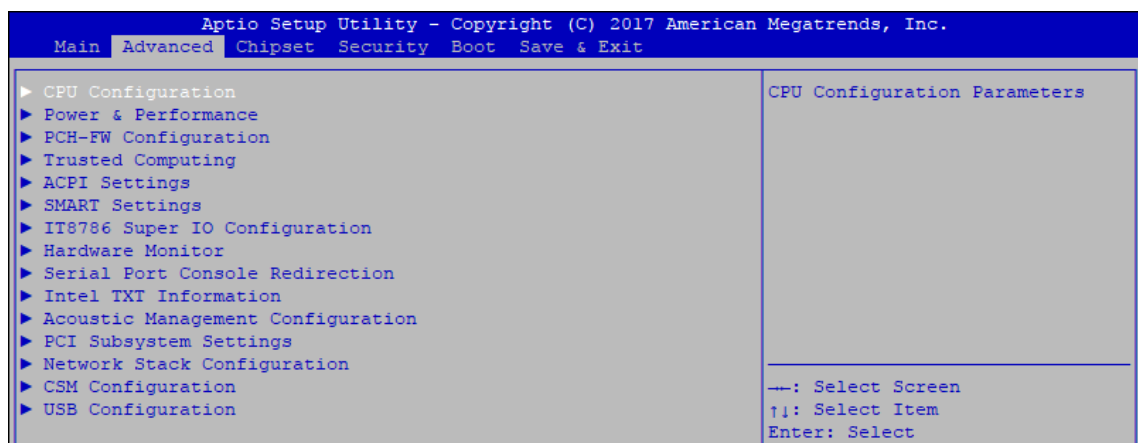

Figure 4-3 : BIOS Advanced Menu

4.3.1 CPU Configuration

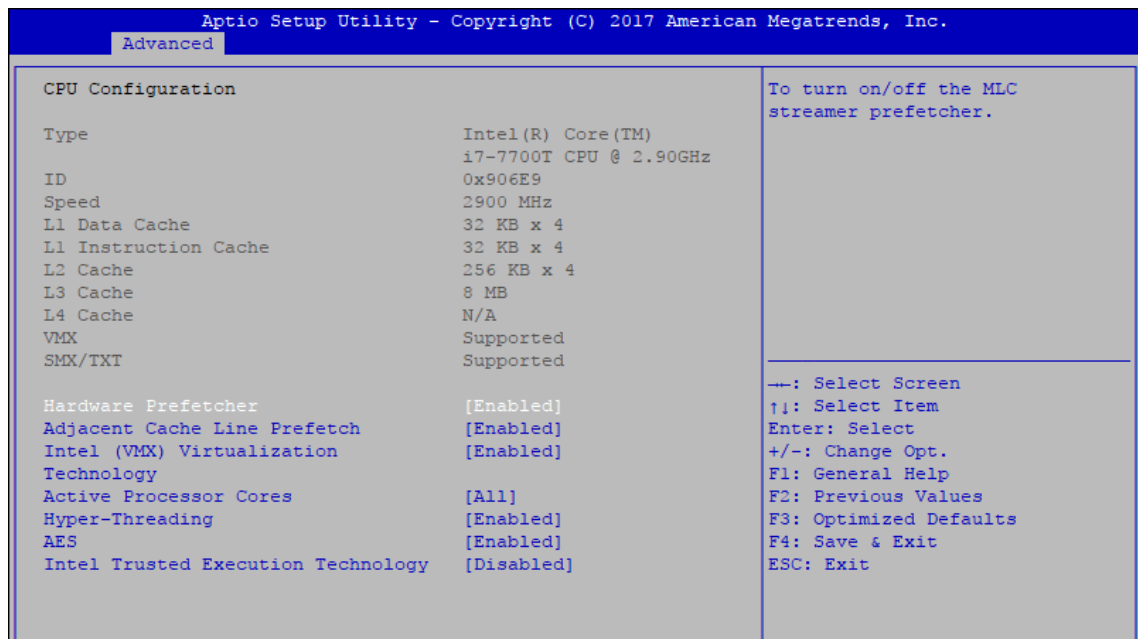

Figure 4-3-1 : CPU Configuration

Hardware Prefetcher

To turn on/off the MLC streamer prefetcher.

Adjacent Cache Line Prefetch

To turn on/off prefetching of adjacent cache lines.

Intel (VMX) Virtualization Technology

When enabled, a VMM can utilize the additional hardware capabilities provided by Vanderpool Technology.

Active Processor Cores

Number of cores to enable in each processor package.

Hyper-threading

Enabled for Windows XP and Linux (OS optimized for Hyper-Threading Technology) and disabled for other OS (OS not optimized for Hyper-Threading Technology). When disabled only one thread per core is enabled.

AES

Enable/disable CPU Advanced Encryption Standard instructions.

Intel Trusted Execution Technology

Enables utilization of additional hardware capabilities provided by Intel® Trusted Execution Technology. Changes require a full power cycle to take effect.

4.3.2 Power & Performance

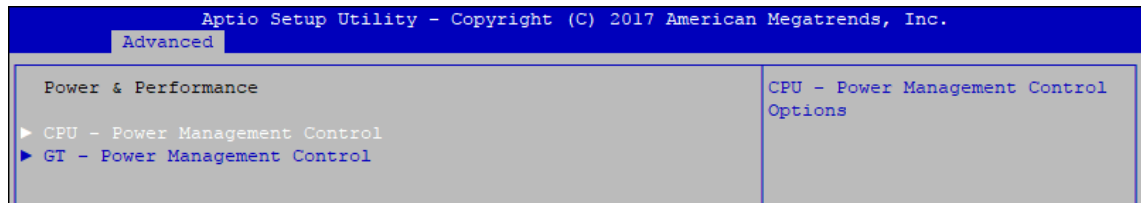

Figure 4-3-2 : Power & Performance

4.3.2.1 CPU – Power Management Control

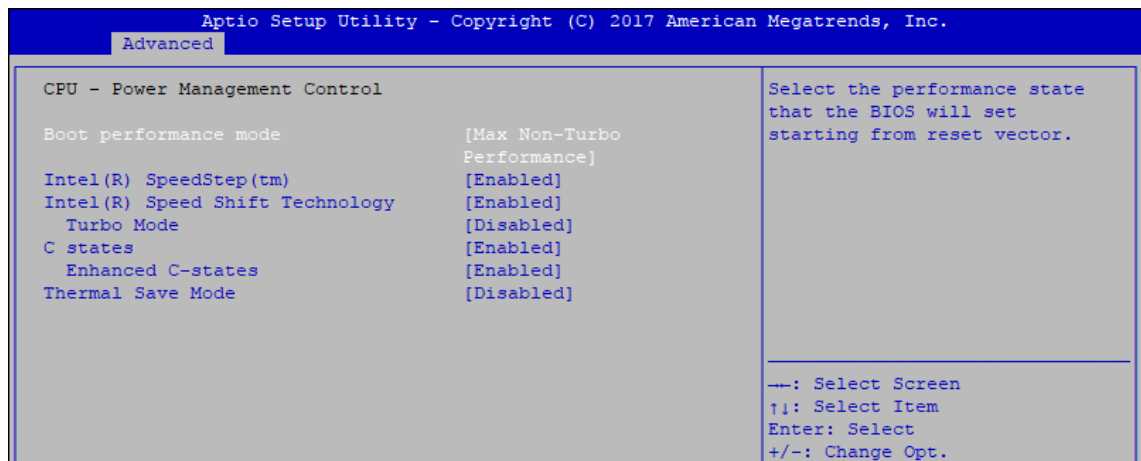

Figure 4-3-2-1 : CPU – Power Management Control

Boot performance mode

Select the performance state that the BIOS will set before OS handoff.

Intel(R) SpeedStep(tm)

Allows more than two frequency ranges to be supported.

Intel(R) Speed shift Technology

Enable/Disable Intel® Speed Shift Technology support. Enabling will expose the CPPCv2 interface to allow for hardware controlled P-states.

Turbo Mode

Turbo Mode.

C states

Enable or disable CPU C states.

Enhanced C-states

Enable/disable C1E. When enabled, CPU will switch to minimum speed when all cores enter C-State.

Thermal Save Mode

Enable/Disable Thermal Save Mode support.

4.3.2.2 GT – Power Management Control

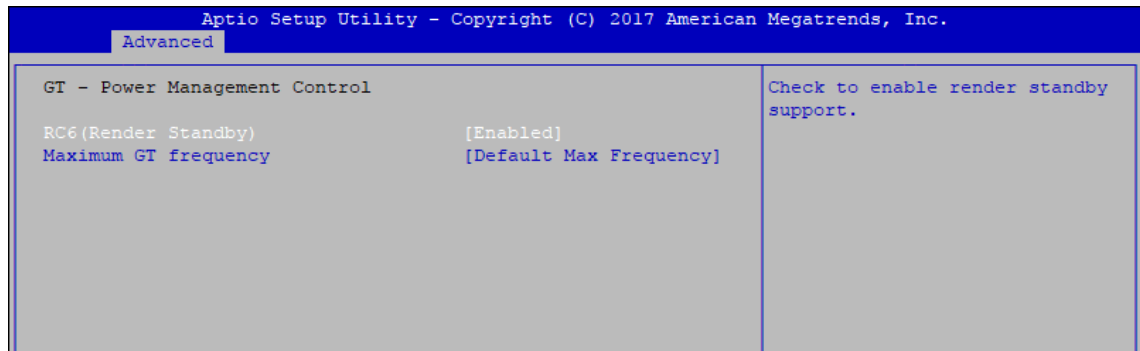

Figure 4-3-2-2 : GT – Power Management Control

RC6 (Render Standby)

Check to enable render standby support.

Maximum GT frequency

Maximum GT frequency limited by the user. Choose between 350MHz (RPN) and 1150MHz (RP0). Value beyond the range will be clopped to min/max supported by SKU

4.3.3 PCH-FW Configuration



Figure 4-3-3 : PCH-FW Settings

ME State

Set ME to soft temporarily dabled.

AMT BIOS Features

When disabled AMT BIOS Features are no longer supported and user is no longer able to access MEBx Setup.

AMT Configuration

Configure Intel® Active Management Technology Parameters.

ME Unconfig on RTC Clear State

Disabling this option will cause ME not to unconfigure on RTC clear.

4.3.4 Trusted Computing

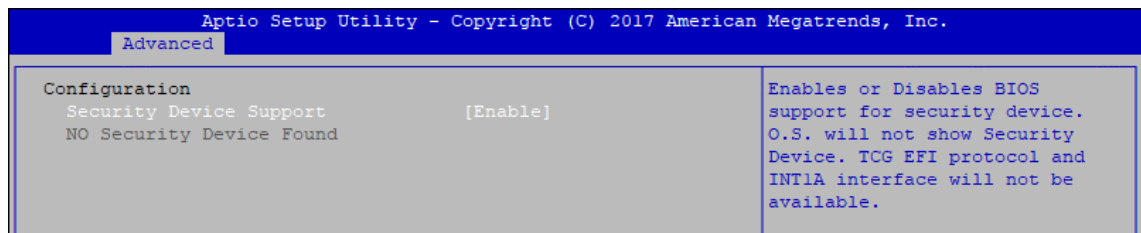

Figure 4-3-4 : Trusted Computing

Control the TPM device status and display related information if TPM chip is present.

4.3.5 ACPI Settings

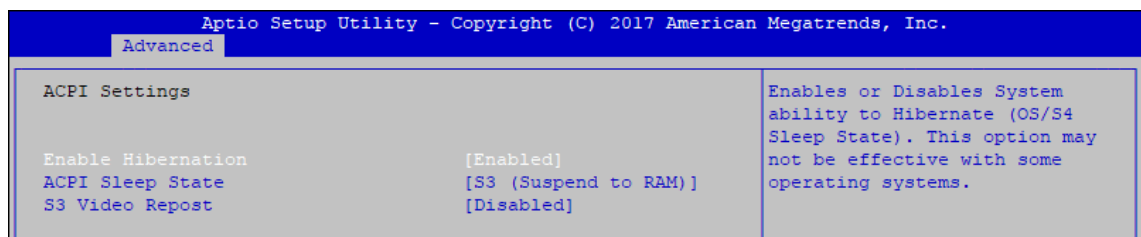

Figure 4-3-5: ACPI Settings

Enable Hibernation

Enables or disables system's ability to hibernate (OS/S4 sleep state). This option may not be effective with some OS.

ACPI Sleep State

Selects the highest ACPI sleep state the system will enter when the SUSPEND button is pressed.

S3 Video Repost

Enables or disables S3 video repost.

4.3.6 SMART Settings

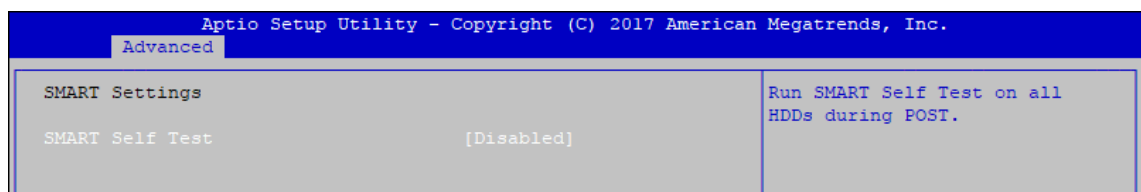

Figure 4-3-6 : SMART Settings

SMART Self Test

Run SMART self test on all HDDs during POST.

4.3.7 IT8786 Super IO Configuration

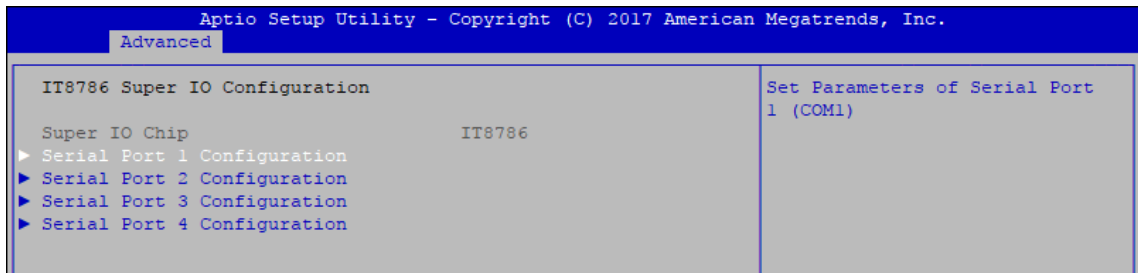

Figure 4-3-7 : IT8786 Super IO Configuration

4.3.7.1 Serial Port X Configuration

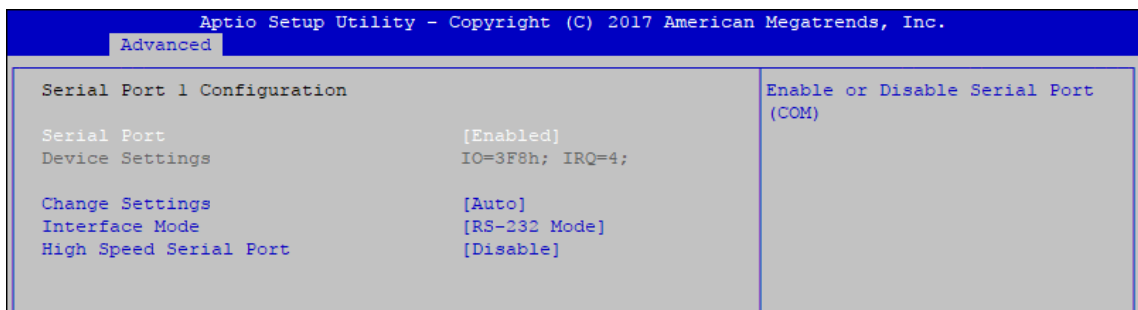

Figure 4-3-7-1 : Serial Port X Configuration

Serial Port 1 to port 4 Configuration

Options for Serial Port 1 to Serial Port 4.

Entering the corresponding Port option then end user can change the settings such as I/O resource and UART mode (High Speed Serial Port is Port 1 only).

4.3.8 Hardware Monitor

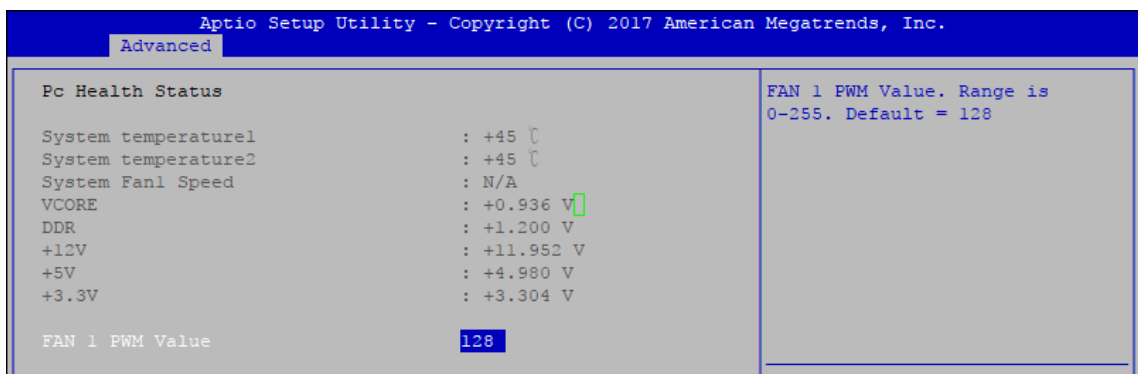

Figure 4-3-8 : Hardware Monitor Settings

The IT8786 SIO features an enhanced hardware monitor providing thermal, fan speed, and system voltages' status monitoring.

Fan 1 PWM Value

FAN 1 PWM Value. Range is 0-255. Default =128, the higher value means more RPM. FAN1 PWM example:

- 100% --> 255
- 90% --> 230
- 80% --> 204
- 70% --> 179
- 60% --> 153
- 50% --> 128
- 40% --> 02
- 30% --> 77
- 20% --> 51
- 10% --> 26

4.3.9 Serial Port Console Redirection

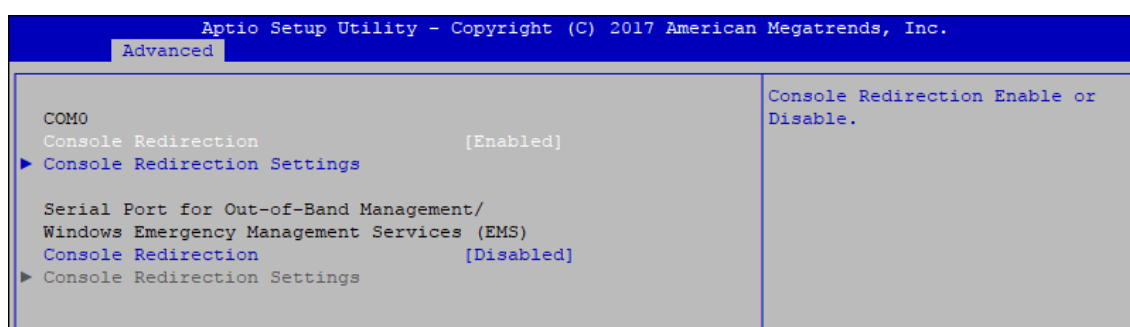

Figure 4-3-9 : Serial Port Console Redirection Settings

Console Redirection

Console redirection enable or disable.

Console Redirection Settings

These settings specify how the host computer and the remote computer (which the user is using) will exchange data. Both computers should have the same or compatible settings.

4.3.10 Intel TXT Information

Display Intel TXT information.



Figure 4-3-10 : Intel TXT Information

4.3.11 Acoustic Management Configuration

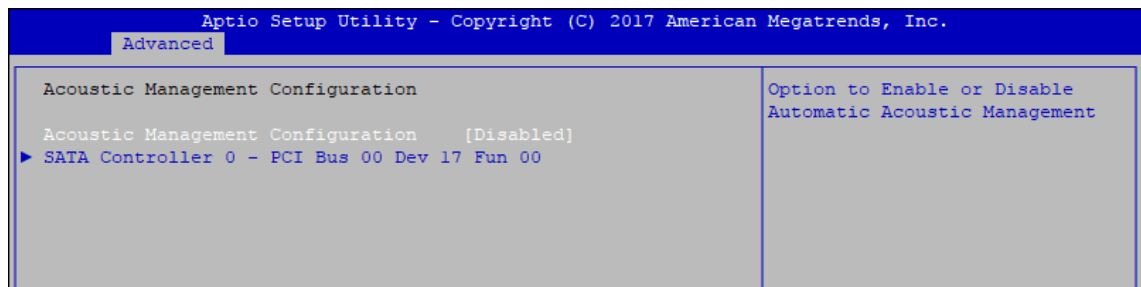

Figure 4-3-11 : Acoustic Management Settings

Acoustic Management Configuration

Option to enable or disable automatic acoustic management.

4.3.12 PCI Subsystem Setting

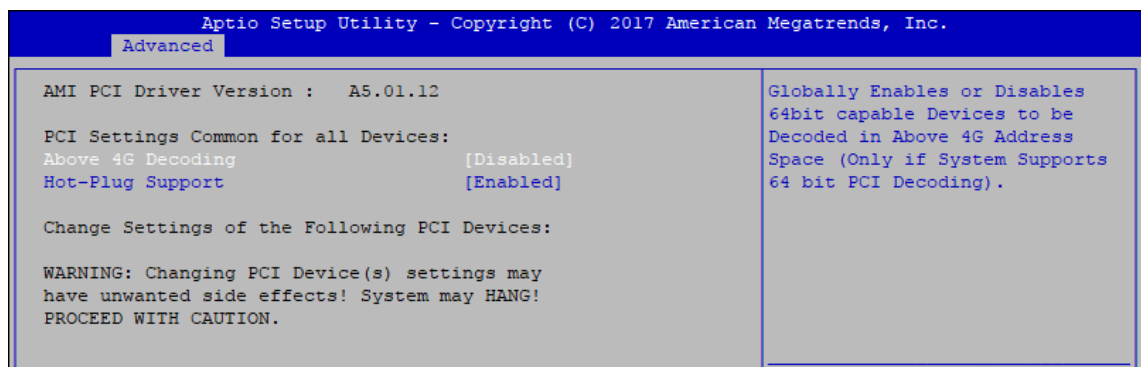

Figure 4-3-12 : PCI Subsystem Settings

Above 4G Decoding

Globally Enables or Disables 64bit capable Devices to be Decoded in Above 4G Address Space (Only if System Supports bot PCI Decoding)

4.3.13 Network Stack Configuration

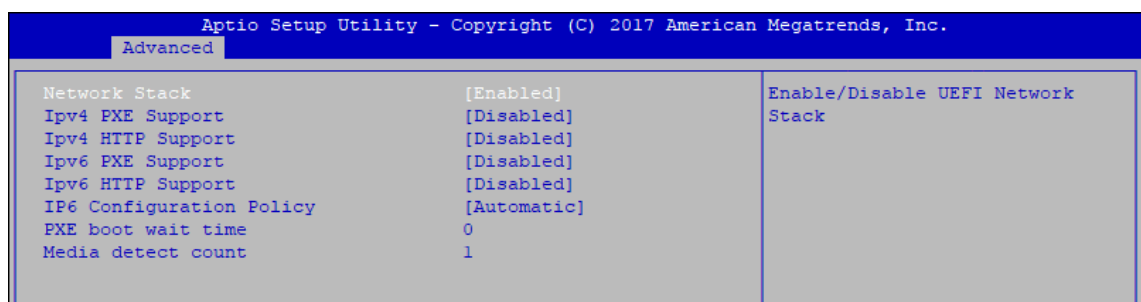

Figure 4-3-13 : Network Stack Configuration

Network Stack

Enable/Disable UEFI Network Stack.

Ipv4 PXE Support

Enable/Disable IPv4 PXE boot support.

Ipv4 HTTP Support

Enable/Disable IPv4 HTTP boot support.

Ipv6 PXE Support

Enable/Disable IPv6 PXE boot support.

Ipv6 HTTP Support

Enable/Disable IPv6 HTTP boot support.

IP6 Configuration Policy

Set IP6 Configuration Policy.

PXE boot wait time

Wait time to press ESC key to abort the PXE boot.

Media detect count

Number of times presence of media will be checked.

4.3.14 CSM Configuration



Figure 4-3-14 : CSM Settings

CSM Support

Enable/disable CSM support.

GateA20 Active

UPON REQUEST-GA20 can be disabled using BIOS services.

ALWAYS - do not allow GA20 to be disabled; this option is useful when any RT code is executed above 1MB.

Option ROM Messages

Set display mode for option ROM.

INT19 Trap Response

BIOS reaction on INT19 trapping by Option ROM:

IMMEDIATE - execute the trap right away;

POSTPONED - execute the trap during legacy boot.

Boot option filter

This option controls Legacy/UEFI ROM's priority.

Network

Controls the execution of UEFI and Legacy PXE OpROM.

Storage

Controls the execution of UEFI and Legacy storage OpROM.

Video

Allows more than two frequency ranges to be supported.

Other PCI devices

Determines OpROM execution policy for devices other than network, storage, or video.

4.3.15 NVMe Configuration

Display NVMe controller and Drive information.

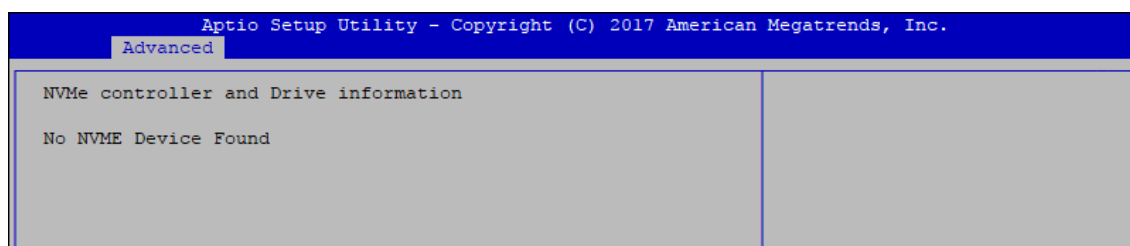

Figure 4-3-15 : NVMe Configuration

4.3.16 USB Configuration



Figure 4-3-16 : USB Settings

Legacy USB Support

Enables Legacy USB support.

AUTO option disables legacy support if no USB devices are connected.

DISABLE option will keep USB devices available only for EFI applications.

XHCI Hand-off

This is a workaround for OSEs without XHCI hand-off support. The XHCI ownership change should be claimed by XHCI driver.

USB Mass Storage Driver Support

Enable/disable USB mass storage driver support.

Port 60/64 Emulation

Enables I/O port 60h/64h emulation support. This should be enabled for the complete USB keyboard legacy support for non-USB aware OS-es.

USB transfer time-out

The time-out value for control, bulk, and interrupt transfers.

Device reset time-out

USB mass storage device start unit command time-out.

Device power-up delay

Maximum time the device will take before it properly reports itself to the host controller. 'Auto' uses default value: for a root port it is 100ms, for a hub port the delay is taken from hub descriptor.

4.4 Chipset Functions

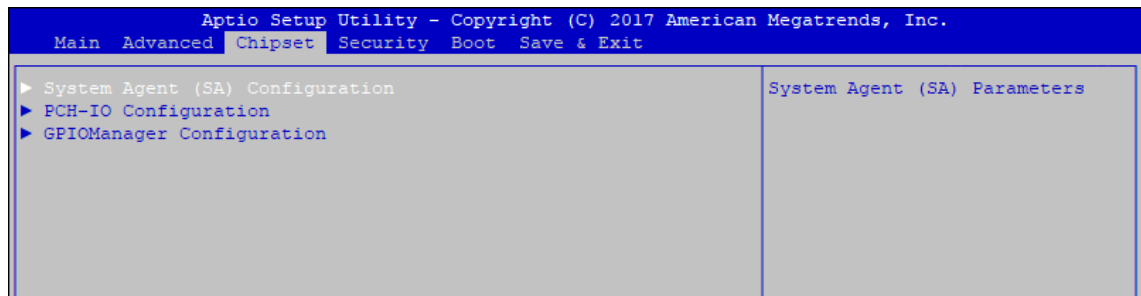

Figure 4-4 : BIOS Chipset Menu

System Agent (SA) Configuration

System Agent (SA) parameters.

PCH-IO Configuration

PCH parameters.

GPIOManager Configuration

GPIOManager parameters.

4.4.1 System Agent (SA) Configuration



Figure 4-4-1 : System Agent Settings

VT-d

VT-d capability.

GMM Device (B0:D8:F0)

Enable/disable SA GMM device.

Above 4GB MMIO BIOS assignment

Enable/disable above 4GB MemoryMappedIO BIOS assignment. This is disabled automatically when aperture size is set to 2048MB.

4.4.1.1 Memory Configuration

Displays memory information.

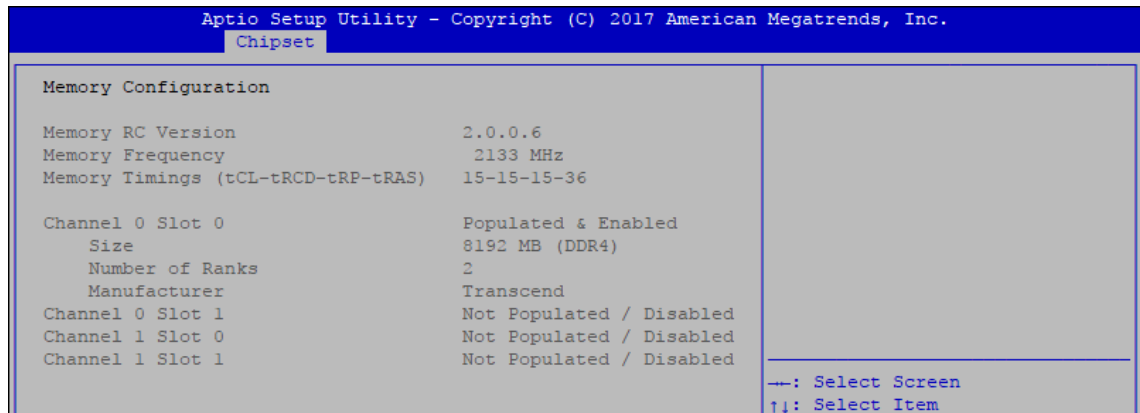

Figure 4-4-1-1: Memory Configuration

4.4.1.2 Graphics Configuration

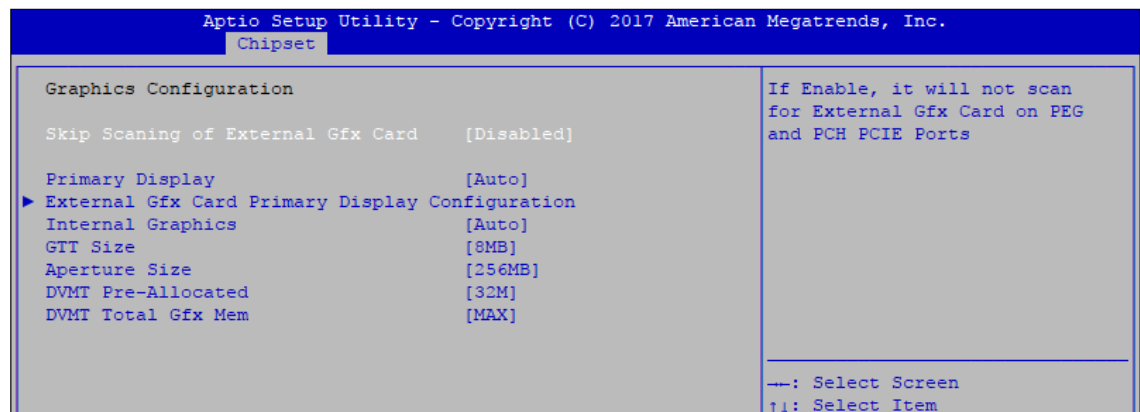

Figure 4-4-1-2 : Graphics Configuration

Skip Scanning of External Gfx Card

If Enable, it will not scan for External Gfx Card on PEG and PCH PCIE Ports.

Primary Display

Select which of IGFX/PEG/PCI Graphics device should be Primary Display Or select SG for Switchable Gfx.

Internal graphics

Keep IGFX enabled based on the setup options.

GTT Size

Select the GTT Size.

Aperture Size

Select the Aperture Size.

Note: Above 4GB MMIO BIOS assignment is automatically enabled when selecting 2048MB aperture. To use this feature, please disable CSM Support.

DVMT Pre-Allocated

Select DVMT 5.0 Pre-Allocated (Fixed) Graphics Memory size used by the Internal Graphics Device.

DVMT Total Gfx Mem

Select DVMT5.0 Total Graphic Memory size used by the Internal Graphics Device.

4.4.1.3 PEG Port Configuration

PEG port options for PCIe device.

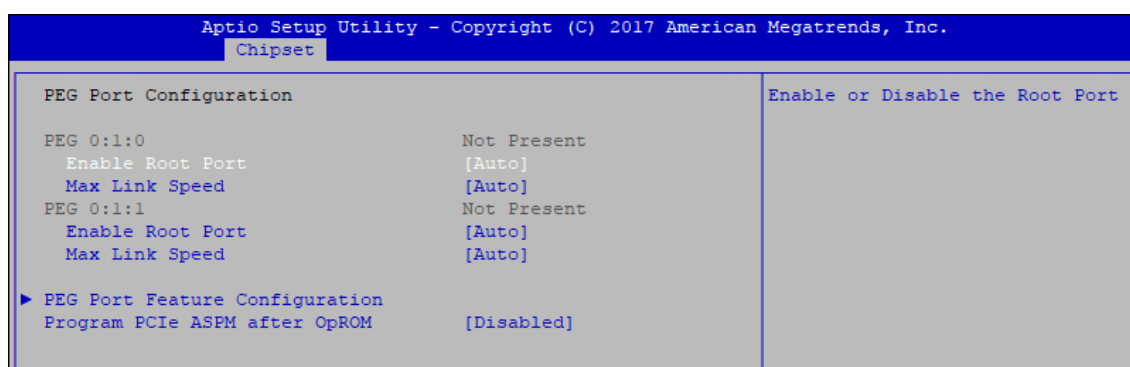

Figure 4-4-1-3 : PEG Port Configuration

4.4.2 PCH-IO Configuration

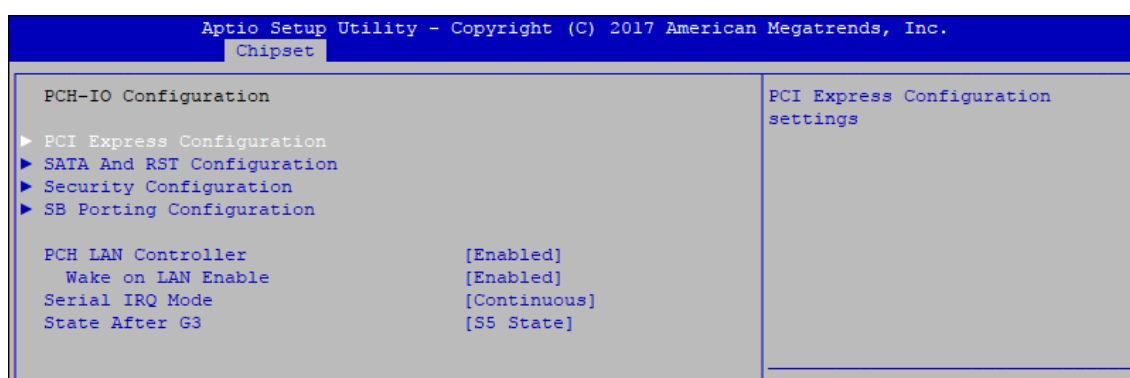

Figure 4-4-2 : PCH-IO Settings

PCH LAN Controller

Enable or disable onboard NIC.

Wake on LAN

Enable or disable integrated LAN to wake the system. (The wake On LAN cannot be disabled if ME is on at Sx state.)

Serial IRQ Mode

Configure serial IRQ mode.

State After G3

Specify what state to go to when power is re-applied after a power failure (G3 state).

S0 State: Always turn-on the system when power source plugged-in.

S5 State: Always turn-off the system when power source plugged-in.

4.4.2.1 PCI Express Configuration of PCH-IO

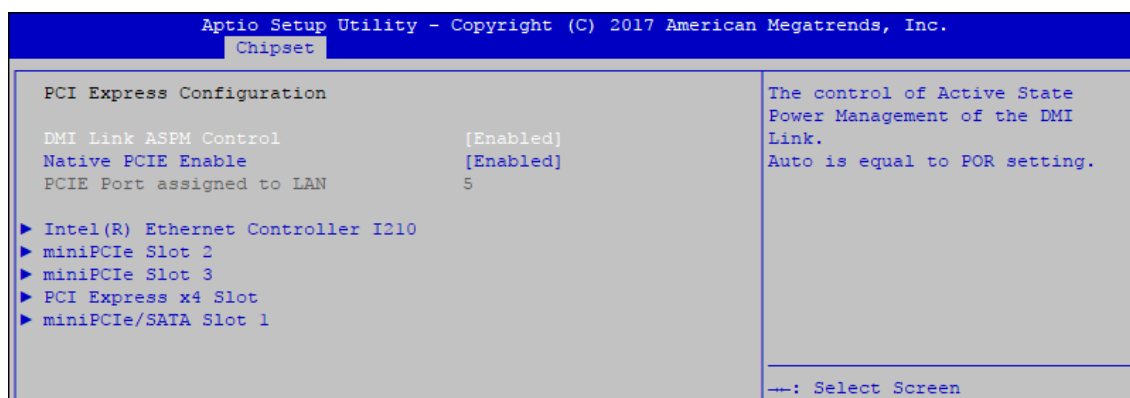

Figure 4-4-2-1: PCH-IO Settings

DMI Link ASPM Control

Enable/Disable the control of Active State Power Management on SA side of the DMI Link.

Native PCIE Enable

PCIE Express Native Support Enable/Disable.

Intel® Ethernet Controller I210

Bios options for PCIe device on Intel® Ethernet Controller I210 LAN.

miniPCIE Slot 1~3

Bios options for PCIe devices on miniPCIE Slot.

PCI Express x4 Slot

Bios options for PCIe device on PCI Express x4 Slot.

4.4.2.2 SATA and RST Configuration

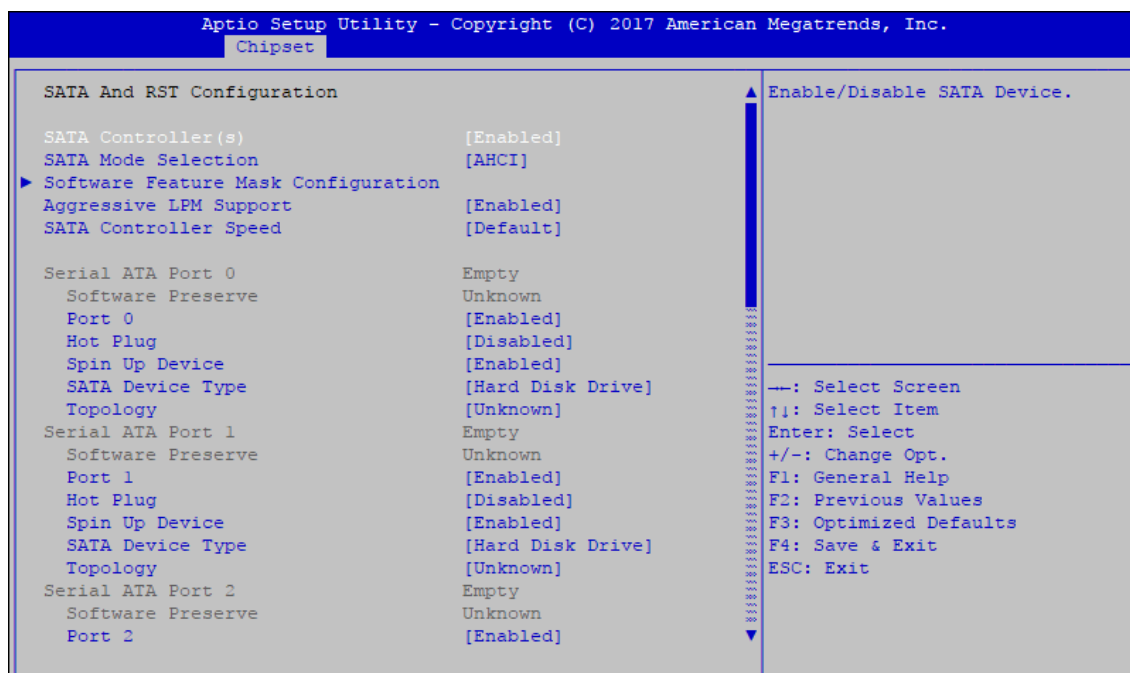

Figure 4-4-2-2 : SATA And RST Settings

SATA Controller(s)

Enable or disable SATA Device.

SATA Mode Selection

Determines how SATA controller(s) operate.

Software Feature Mask Configuration

RAID OROM/RST driver will refer to the SWFM configuration to enable or disable the storage features.

Aggressive LPM Support

Enable PCH to aggressively enter link power state.

SATA Controller Speed

Indicates the maximum speed the SATA controller can support.

Options for each SATA port:

Port n

Enable or disable SATA Port.

Hot Plug

Designated this port as Hot Pluggable.

Spin Up Device

On an edge detect from 0 to 1, the PCH starts a COMRESET initialization sequence to the device.

SATA Device Type

Identifies that the SATA port is connected to solid state drive or hard disk drive.

Topology

Identify the SATA Topology if it is Default or ISATA or Flex or DirectConnect or M2.

4.5 Security

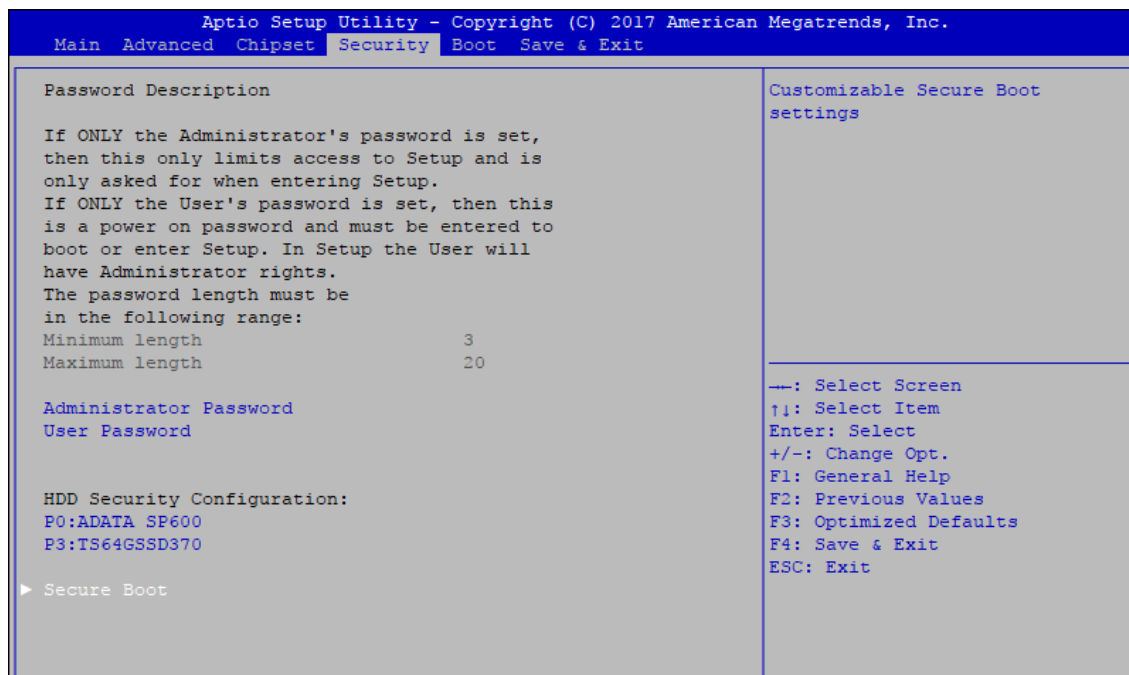

Figure 4-5 : BIOS Security Menu

Administrator Password

Set administrator password.

User Password

Set user password.

Secure Boot

Customizable Secure Boot Settings.

4.5.1 HDD Security Configuration

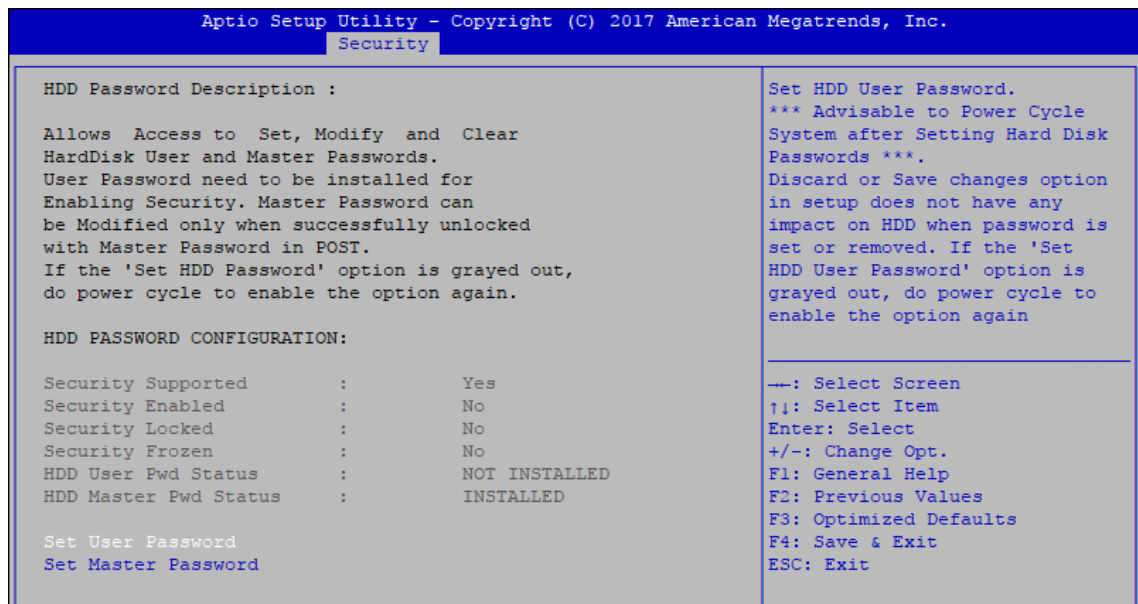

Figure 4-5-1 : HDD Security Settings

Set User Password

Set HDD user password.

*** Advisable to power cycle system after setting hard disk passwords ***

Discard or save changes option in setup does not have any impact on HDD when password is set or removed. If the 'Set HDD User Password' option is gray, do power cycle to enable the option again.

4.5.2 Security Boot

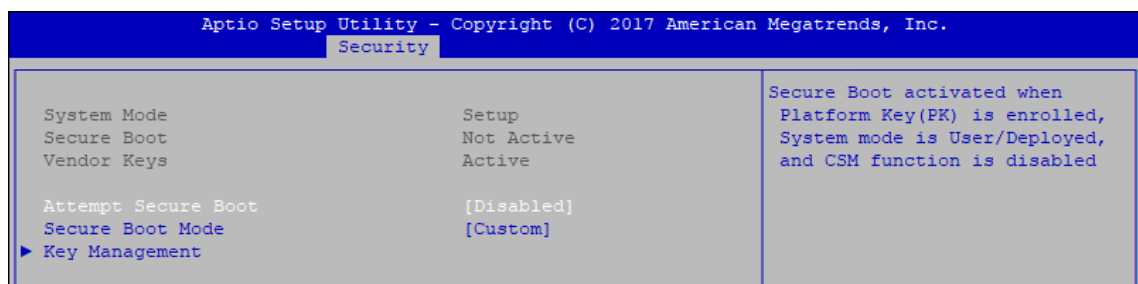

Figure 4-5-2 : Security Boot Settings

Attempt Secure Boot

Secure Boot activated when Platform Key (PK) is enrolled, System mode is User/Deployed, and CSM function is disabled.

Secure Boot Mode

Secure Boot mode selector Standard/Custom.

In custom mode Secure Boot Variables can be configured without authentication.

Key Management

Enables expert users to modify Secure boot policy variables without full authentication.

4.6 Boot

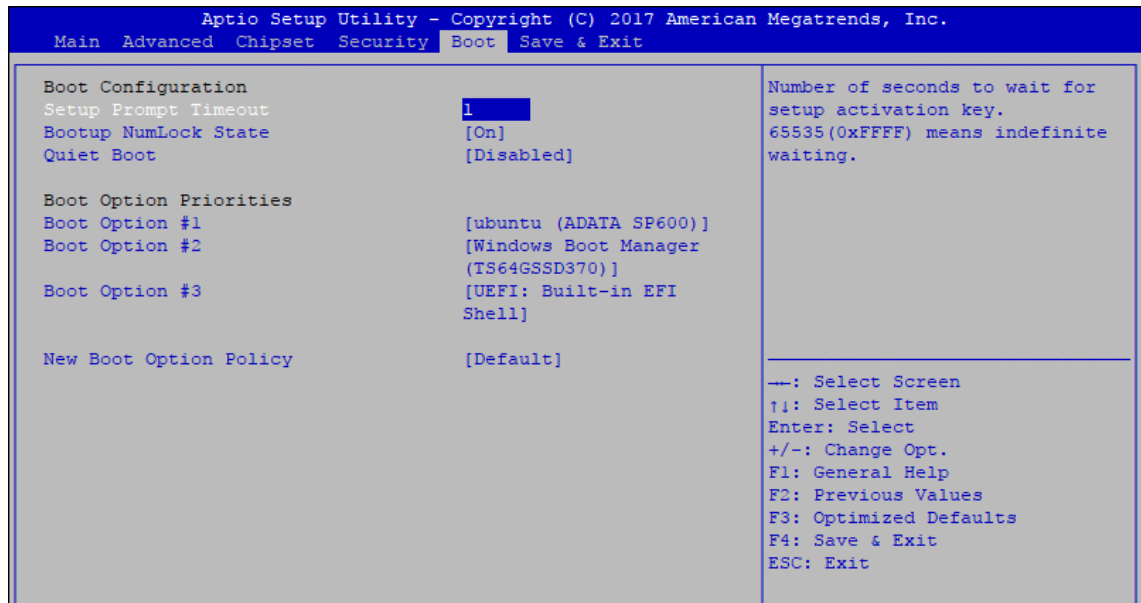

Figure 4-6 : BIOS Boot Menu

Setup Prompt Timeout

Number of seconds to wait for setup activation key. 65535(0xFFFF) means indefinite waiting.

Bootup NumLock State

Select the keyboard NumLock state.

Quiet Boot

Enables or disables quiet boot option.

Boot Option

Sets the system boot order.

New Boot Option Policy

Controls the placement of newly detected UEFI boot options.

Hard Drive BBS Priorities

Set the order of the Legacy devices in this group.

4.7 Save & Exit

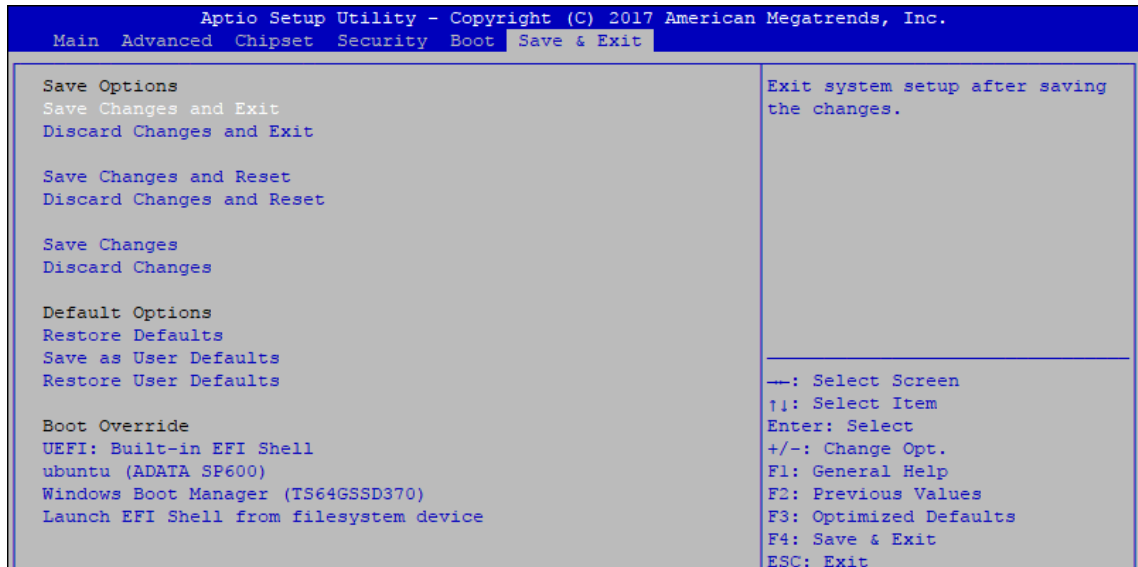

Figure 4-7 : Bios Save and Exit Menu

Save Changes and Exit

Exit system setup after saving the changes.

Discard Changes and Exit

Exit system setup without saving any changes.

Save Changes and Reset

Reset the system after saving the changes.

Discard Changes and Reset

Reset system setup without saving any changes.

Save Changes

Save changes done so far to any of the setup options.

Discard Changes

Discard changes done so far to any of the setup options.

Options Options:

Restore Defaults

Restore/load default values for all the setup options.

Save as User Defaults

Save the changes done so far as user defaults.

Restore User Defaults

Restore the user defaults to all the setup options.

A

APPENDIX A : Isolated DIO Guide

A.1 Function Description

The RCS-9000 offers two 16-bit isolated DIO 20-pin terminal block connector, a 16-bit GPIO 26-pin internal connector, and a watchdog timer. Isolated DIO pins are fixed by Hardware design that cannot change in/out direction in runtime process. DIO definition is shown below:

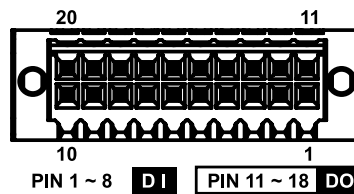

Pin No.	DIO Definition	Pin No.	DIO Definition
1	DIO	11	DO0
2	DIO	12	DO1
3	DIO	13	DO2
4	DIO	14	DO3
5	DIO	15	DO4
6	DIO	16	DO5
7	DIO	17	DO6
8	DIO	18	DO7
9	DI COM	19	DIO GND
10	DIO GND	20	External VDC

GPIO definition is shown below:

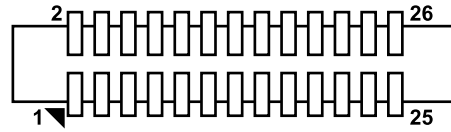

Pin No.	Description	Pin No.	Description
1	GND	14	GND
2	GPIO 15	15	GPIO 7
3	GPIO 14	16	GPIO 6
4	GPIO 13	17	GPIO 5
5	GPIO 12	18	GPIO 4
6	GND	19	GND
7	GPIO 11	20	GPIO 3
8	GPIO 10	21	GPIO 2
9	GPIO 9	22	GPIO 1
10	GPIO 8	23	GPIO 0
11	GND	24	GND
12	CP	25	5V
13	CP	26	5V

A.2 Isolated DIO Signal Circuit

DI signal circuit in SINK mode (NPN) is illustrated as follows.
(For 24V DC Diagram)

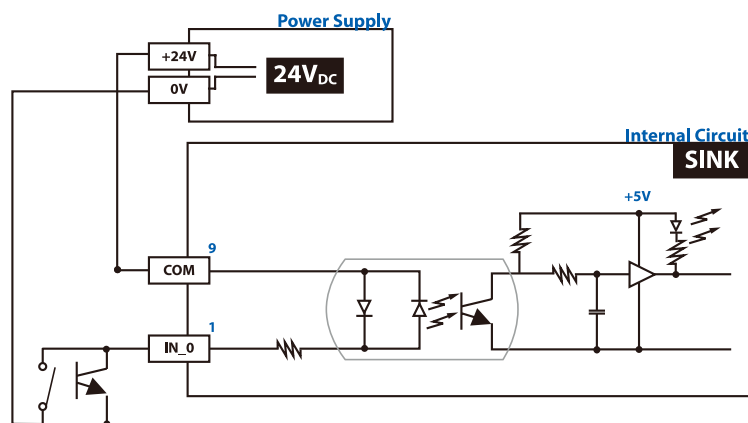

DI signal circuit in SOURCE mode (PNP) is illustrated as follows.
(For 24V DC Diagram)

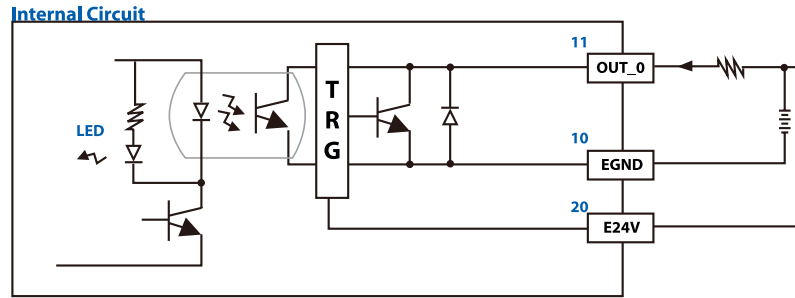

DO signal circuit in SINK mode (NPN) is illustrated as follows.
(For 24V DC Diagram)

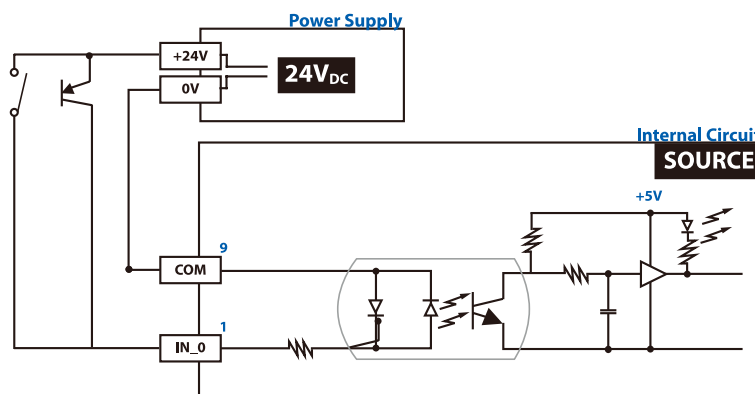

A.3 Software Package Contain

Distribution folder include x32 and x64 versions, use batch file for installation.

There are included as followed:

Win7_32.bat:

Installation for 32-bit driver

Win7_64.bat:

Windows update package which driver required (need to restart), and Installation for 64-bit driver

Win8_32.bat, Win8_64.bat:

Installation for driver, and guideline to Framework 3.5 distribution for sample

Win10_32.bat, and Win10_64.bat:

Installation for driver, and installation to Framework 3.5 distribution for sample

Uninstall_32.bat, and Uninstall_64.bat:

Uninstallation for driver

Run batch file as Administrator.

Support Windows 7 above.

Make sure Windows version before installation.

- Distribution
- Runtime
- Sample
- Source
- Uninstall_32
- Uninstall_64
- Win7_32
- Win7_64
- Win8_32
- Win8_64
- Win10_32
- Win10_64

Runtime folder include head file for software developer or System Integration.
 Sample folder include sample program, driver library, and API library.
 Source folder include sample program source code that compile on Visual Studio 2008.

A.4 Sample

Execute DIO demo tool (RCS9K.exe).

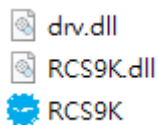

Sample RCS9K.exe, as shown below:

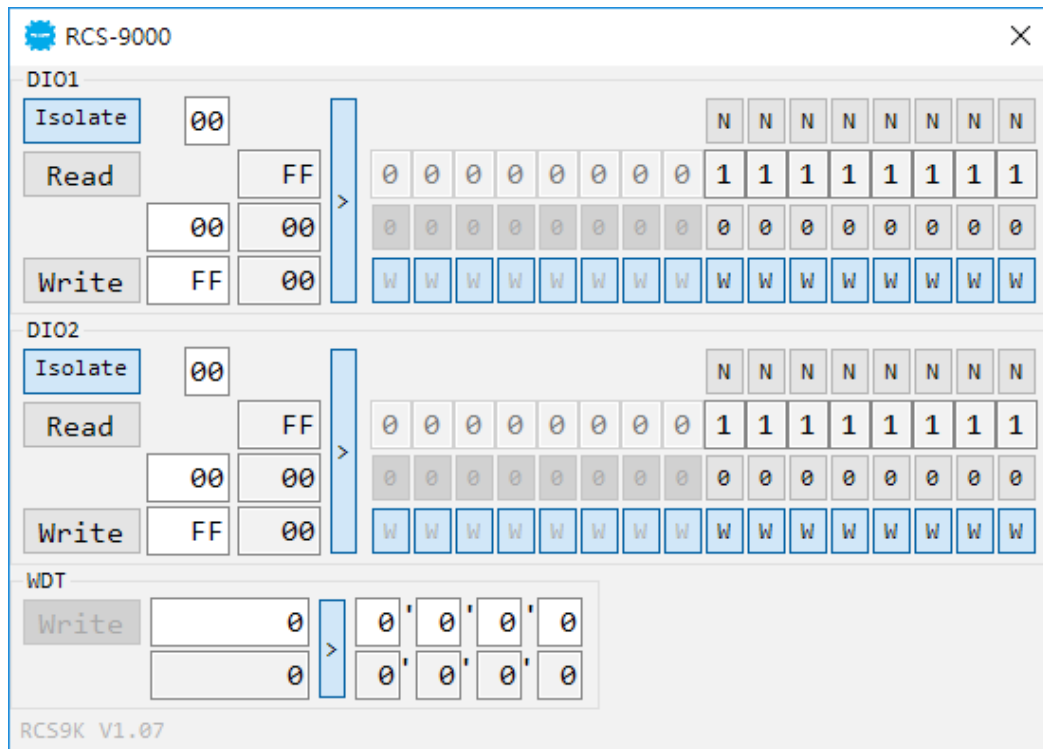

DIO1 / DIO2 group:

Isolate check button:

DIO type of DIO configuration, isolated / non-isolated.

Non-Isolated DIO1 is the same as GPIO.

Read button:

Set DIO configuration to get DI / DIO input state.

Write button:

Set DIO configuration to set DO / DIO output state.

DI preference text:

User setting, DI type of DIO configuration

by hexadecimal bitmask - Source / Sink.

Use for Read (DI) button activate.

DO / DIO output text:

User setting, DO / DIO output state by hexadecimal bitmask - on / off.
Use for Write button activate.

DO / DIO writable text:

User setting, DO / DIO writable of DIO configuration
by hexadecimal bitmask - yes / no.
Use for Read (DIO) / Write button activate.

DI / DIO input text (read only):

DI / DIO input state by hexadecimal bitmask – on /off.
Use for Read button activate.

DO / DIO text (read only):

DO / DIO output state with input state (DIO) and configuration.
Use for Write button activate.

DO / DIO output text (read only):

DO / DIO output state with configuration.
Use for Write button activate.

DI type pin texts (pin 8 ~ pin 1):

User setting, DI pin type of DIO configuration - Source / Sink.

DI / DIO input pin texts (read only, pin 8 ~ pin 1 / pin 18 ~ pin 11, pin 8 ~ pin 1):

DI / DIO input pin state
Use for Read button activate.

DO / DIO output pin texts (pin 18 ~ pin 11 / pin 18 ~ pin 11, pin 8 ~ pin 1):

User setting, DO / DIO output pin state
Use for Write button activate.

DO / DIO pin writable texts (pin 18 ~ pin 11 / pin 18 ~ pin 11, pin 8 ~ pin 1):

User setting, DO / DIO pin writable of DIO configuration.
Use for Read (DIO) / Write button activate.

WDT group:

Write button:

Set WDT when WDT setup text is valid.

Stop button:

Cancel WDT and counting.
Use after Write button action.

WDT setup text:

User setting, WDT value, unit: second.
Use for Write button activate.

WDT counting text (read only):

WDT counting by program timer after set WDT.
Shown after Write button action.

WDT setup day format texts (user setting):

User setting, WDT value, format: day'hour'minute'second.

WDT counting day format text (read only):

WDT counting, format: day'hour'minute'second.

B

APPENDIX B : Software Functions

B.1 Driver API Guide

In Runtime folder, on RCS9K2.h:

`_DLL_IMPORT_` definition is used on LoadLibrary API for RCS9K.dll.

`RCS9K_EXPORTS` definition is used on RCS9K.dll building.

Otherwise, that is used to compile with RCS9K.lib

BOOL Initial(BYTE Isolate_Type, BYTE DIO_NPN)

Initial machine for DIO, watchdog timer, and POE

Isolate_Type: DIO type

1: Isolated DIO;

0: Non-Isolated DIO

DIO_NPN: DI / DO type

1: PNP (Source) mode for European rule;

0: NPN (Sink) mode for Japanese rule

Return:

TRUE (1): Success;

FALSE (0): Fail (Driver not exists, or initial error (version is too old, or machine not match))

BOOL GetDIO1Config(BYTE *Isolate_Type, BYTE *DI_NPN, WORD *Mask)

BOOL GetDIO2Config(BYTE *Isolate_Type, BYTE *DI_NPN, WORD *Mask)

Get DIO configuration(by variable)

Isolate_Type: DIO type

1: Isolated DIO;

0: Non-Isolated DIO (DIO1 is the same as GPIO)

DI_NPN ([7:0]): DI type, pin setting by hexadecimal bitmask

1: PNP (Source) mode for European rule;

0: NPN (Sink) mode for Japanese rule

DO_NPN: DO type

1: PNP (Source) mode for European rule;

0: NPN (Sink) mode for Japanese rule

Mask ([15:0]): In / Out, pin setting by hexadecimal bitmask

1: Output;

0: Input

Return:

TRUE (1): Success;

FALSE (0): Fail (Initial error, or call by pointer error, or hardware problem)

BOOL SetDIO1Config(BYTE *Isolate_Type, BYTE *DI_NPN, BYTE *DO_NPN, WORD *Mask)

BOOL SetDIO2Config(BYTE *Isolate_Type, BYTE *DI_NPN, BYTE *DO_NPN, WORD *Mask)

Set DIO configuration

Isolate_Type: DIO type

1: Isolated DIO;

0: Non-Isolated DIO (DIO1 is the same as GPIO)

DI_NPN ([7:0]): DI type, pin setting by hexadecimal bitmask

1: PNP (Source) mode for European rule;

0: NPN (Sink) mode for Japanese rule

DO_NPN: DO type

1: PNP (Source) mode for European rule;

0: NPN (Sink) mode for Japanese rule

Mask ([15:0]): In / Out, pin setting by hexadecimal bitmask

1: Output;

0: Input

Return:

TRUE (1): Success;

FALSE (0): Fail (Initial error, or hardware problem)

BOOL GetDI1(BYTE *DI)

BOOL GetDI2(BYTE *DI)

Get isolated DIO input (DI)

DI ([7:0]): Input state, pin setting by hexadecimal bitmask

1: High;

0: Low

Return:

TRUE (1): Success;

FALSE (0): Fail (Initial error, or call by pointer error, or hardware problem)

BOOL GetDO1(BYTE *DO)

BOOL GetDO2(BYTE *DO)

Get isolated DIO output (DO)

DO ([7:0]): Output state, pin setting by hexadecimal bitmask

1: High;

0: Low

Return:

TRUE (1): Success;

FALSE (0): Fail (Initial error, or call by pointer error, or hardware problem)

BOOL SetDO1(BYTE DO)

BOOL SetDO2(BYTE *DO)

Set isolated DIO output (DO)

DO ([7:0]): Output state, pin setting by hexadecimal bitmask

1: High;

0: Low

Return:

TRUE (1): Success;

FALSE (0): Fail (Initial error, or hardware problem)

BOOL GetDIO1(WORD *DI) (it is the same as GPIO)

BOOL GetDIO2(WORD *DI)

Get non-isolated DIO input (DIO input)

DI ([15:0]): Input state, pin setting by hexadecimal bitmask

1: High;

0: Low

Return:

TRUE (1): Success;

FALSE (0): Fail (Initial error, or call by pointer error, or hardware problem)

BOOL SetDIO1(WORD DO) (it is the same as GPIO)

BOOL SetDIO2(WORD DO)

Set non-isolated DIO output (DIO output)

DO ([15:0]): output state, pin setting by hexadecimal bitmask

1: High;

0: Low

Return:

TRUE (1): Success;

FALSE (0): Fail (Initial error, or hardware problem)

BOOL GetWDT(DWORD *WDT)

Get watchdog timer setup

WDT: watchdog timer setup

Unit: second. (Range: 0 ~ 65535 sec, 1093 ~ 65535 min
(=65580 ~ 3932100 sec))

Return:

TRUE (1): Success;

FALSE (0): Fail (Initial error, or call by pointer error, or hardware problem)

BOOL SetWDT(DWORD WDT)

Set watchdog timer setup

WDT: watchdog timer setup

Unit: second. (Range: 0 ~ 65535 sec, 1093 ~ 65535 min
(=65580 ~ 3932100 sec))

Return:

TRUE (1): Success;

FALSE (0): Fail (Initial error, or call by pointer error, or hardware problem)

BOOL CancelWDT()

Cancel watchdog timer

Return:

TRUE (1): Success;

FALSE (0): Fail (Initial error, or hardware problem)

C

APPENDIX C : RAID Installation Guide

C.1 SATA Mode for RAID

C.1.1 SATA Mode for RAID

Please select SATA device to RAID mode on BIOS menu.

Advanced → SATA Configuration → SATA Mode Selection → RAID (Skylake platform)/Intel RST Premium (Kaby Lake platform)

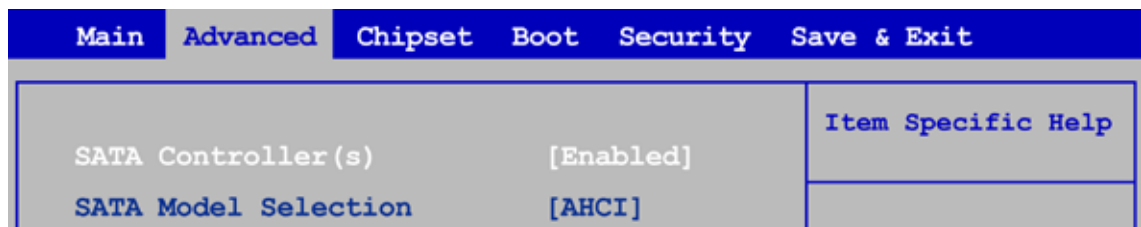

C.1.2 UEFI Mode for RAID

1. Please select SATA device to RAID mode on BIOS menu.

Advanced → SATA Configuration → SATA Mode Selection → RAID (Skylake platform)/Intel RST Premium (Kaby Lake platform)

2. Please select Software Feature Mask Configuration on BIOS menu.

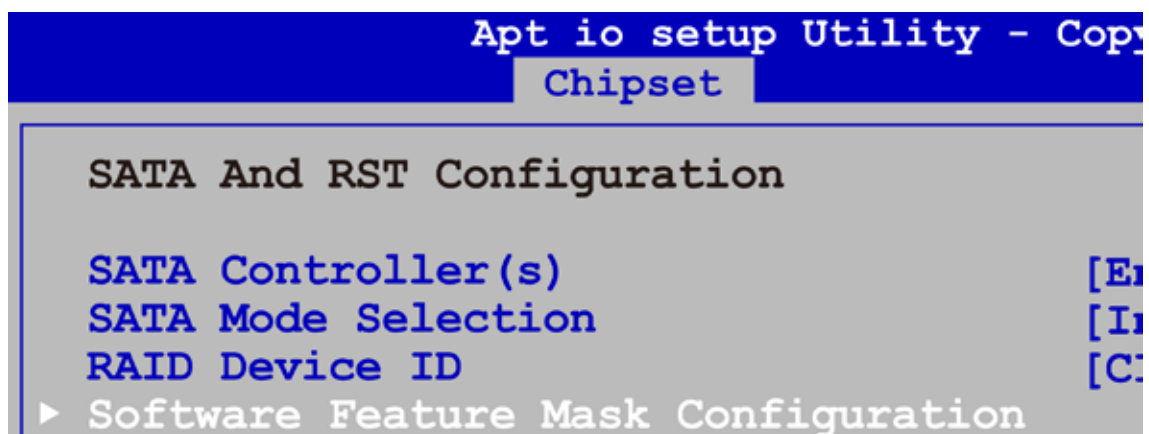

3. Use RST Legacy → Disabled → Save Changes and Reset.

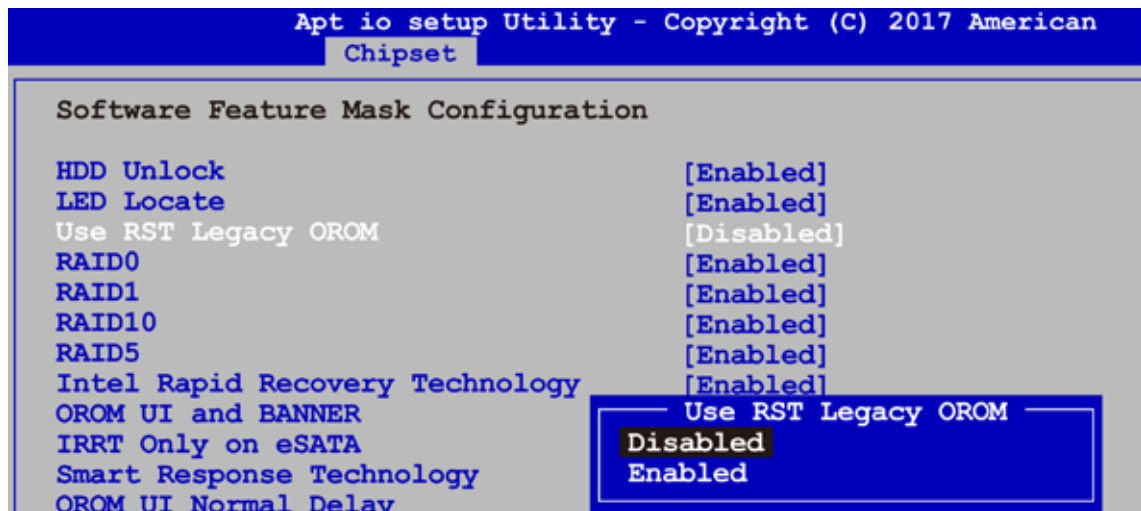

4. Into BIOS menu again, select Intel(R) Rapid Storage Technology on BIOS menu.

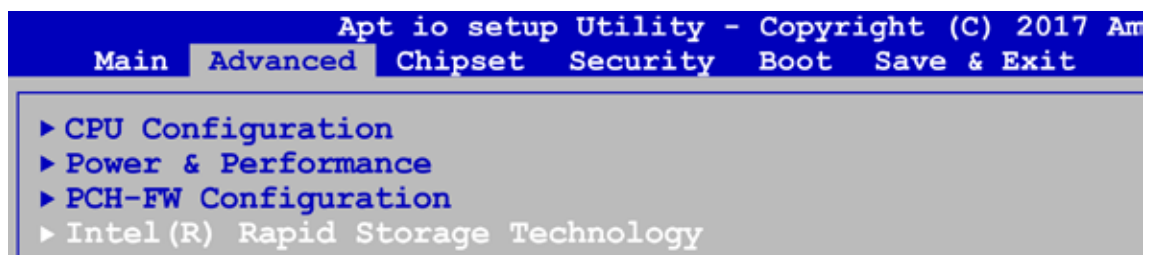

5. Select Create RAID Volume on BIOS menu.

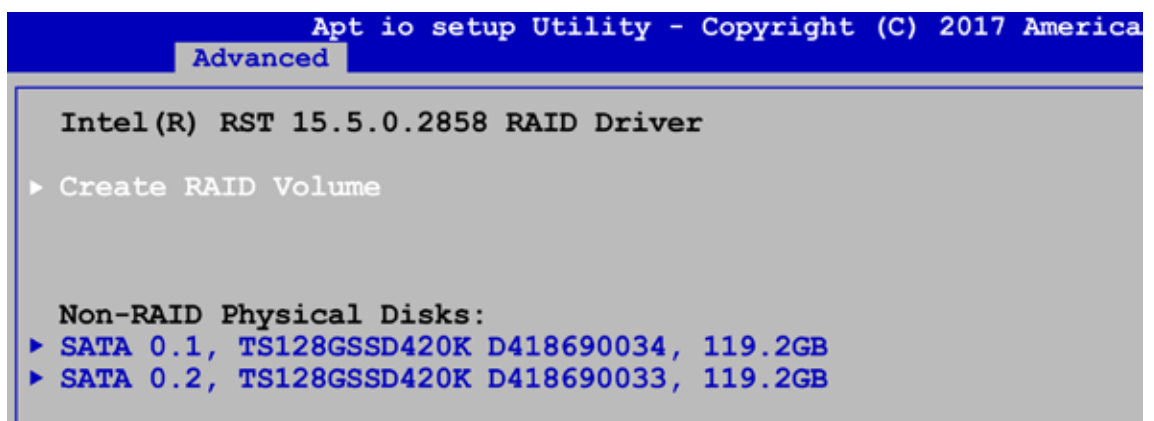

6. Select disks to create RAID Volume then Save Changes and Reset to install OS with EFI mode.

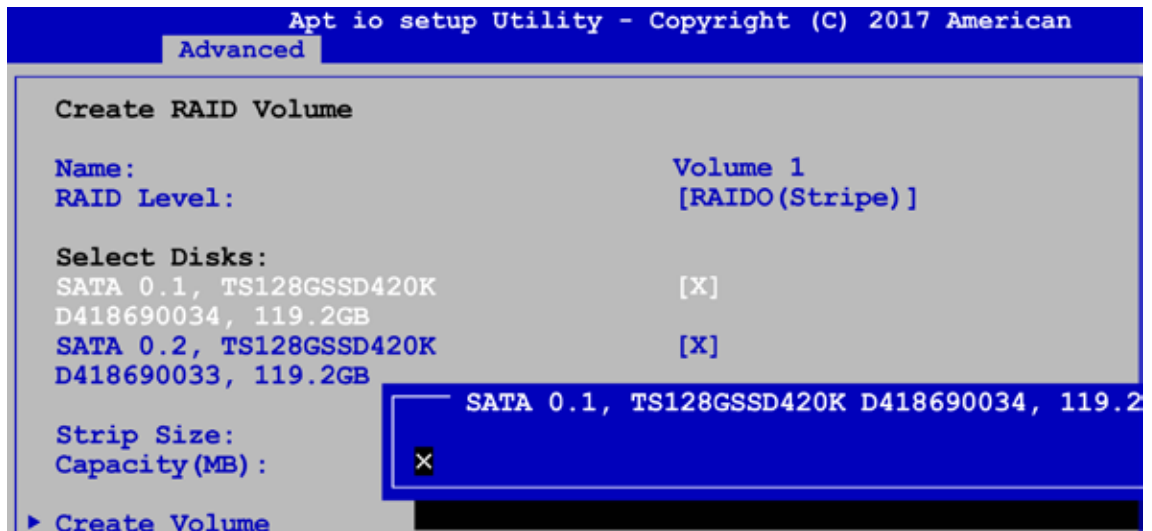

C.2 OS Installation

The system has six SATA, including four internal SATA, one mSATA and one CFast. You can select one of the SATA ports for OS installation. We used CFast card for Windows 10 OS installation as an example.

C.3 To Install All Device Drivers of the System

The instructions are as follows :

1. Install Chipset driver
2. Install Network driver
3. Install ME driver (if available)
4. Install Audio driver
5. Install VGA driver

C.4 To Install "Intel Rapid Storage Technology" Software

You can get the software on driver CD.

Also, you can find the latest information and software directly from Intel's website.

http://www.intel.com/p/en_US/support/highlights/chpsts/imsm

The RAID environment has been done if you completed the steps above.

C.5 To Insert SATA HDD for RAID 1

Please note, you can use two SATA ports for SATA HDD, except for mSATA slot.

C.6 To Create RAID Volume on "Rapid Storage Technology" Software

The system is featured with four SATA HDD's for RAID volume, so there are RAID level options to choose on this page. Let's take RAID 1 as an example, select "RAID 1".



C.7 Disk Management : Partition the Disk

After RAID 1 volume is created, you can see the figure of SATA device allocation.

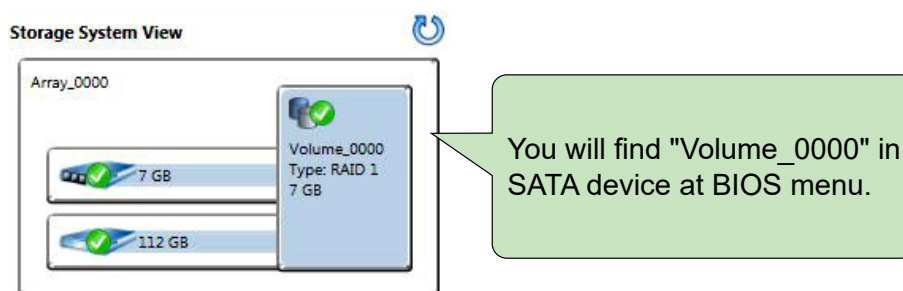

To start disk management tool, select "initialize disk".

Then add "Logical Device" for Windows access.

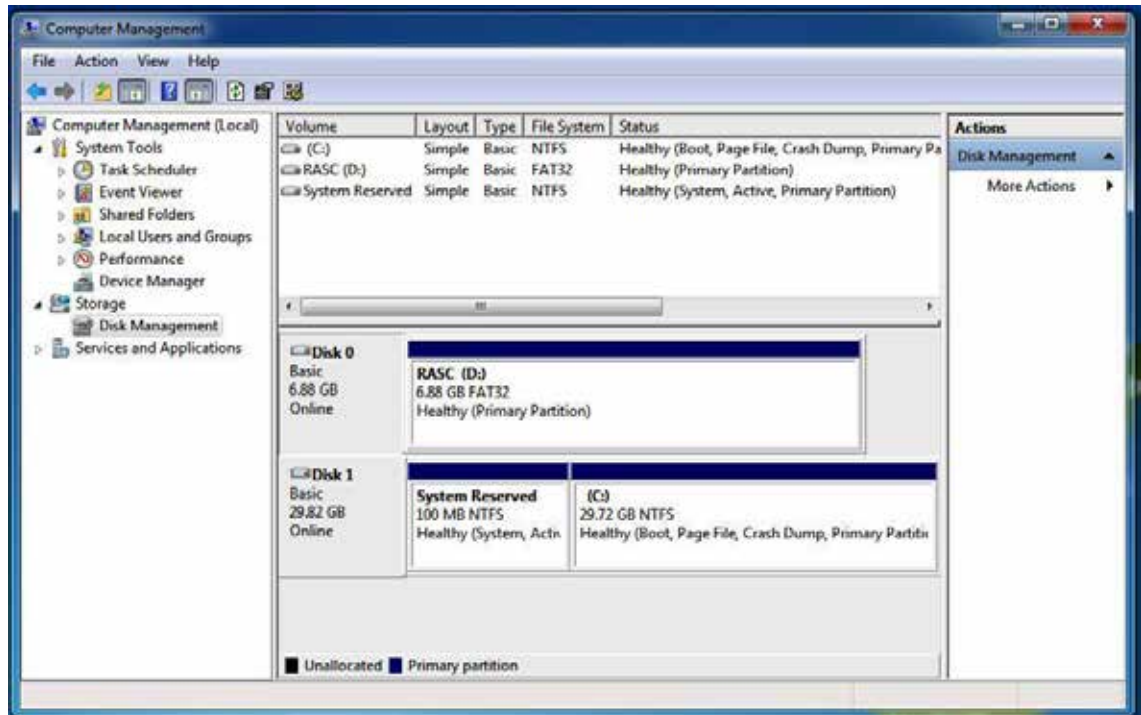

C.8 If One SATA HDD on RAID Volume is Out-of-use

After RAID 1 volume is created, you can see the figure of SATA device allocation.

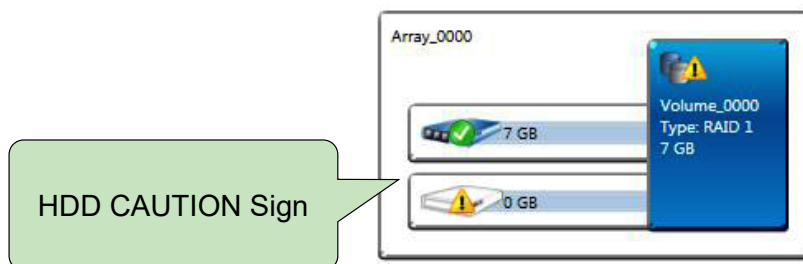

C.9 Recovery and Auto Re-build When Using the SAME RAID HDD

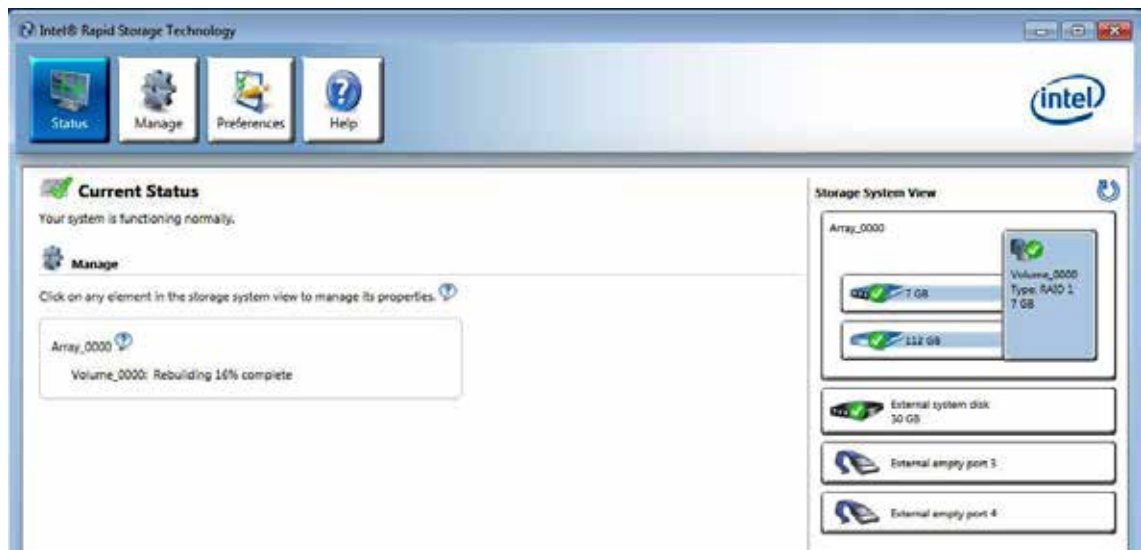

C.10 Recovery and Auto Re-build When Using DIFFERENT RAID HDD

A warning will pop-up to ask you if the disk is not a member of the original RAID volume.

If you press "Rebuild", it will replace the broken SATA HDD to the last SATA HDD of RAID volume.

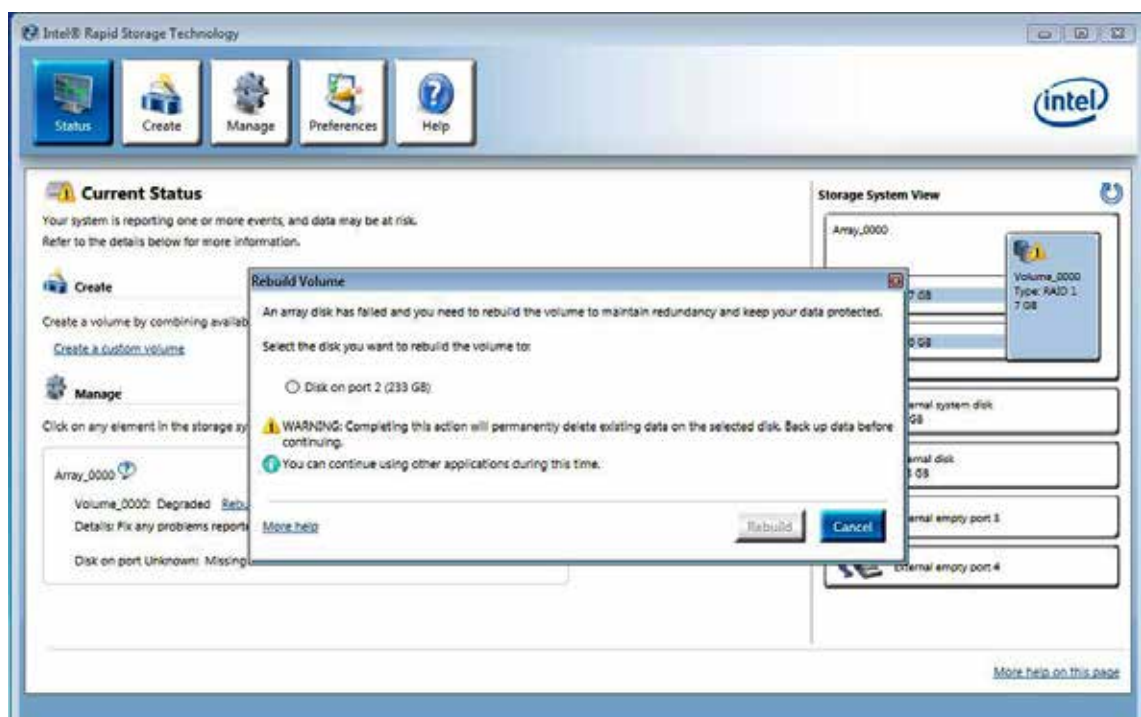

D

APPENDIX D : Power Consumption

Testing Board	RCS-9000F GTX1080
RAM	MEMXPRO 8GB *2
SATA 0	TOSHIBA SSD THNS064GE4BBDC 64GB
SATA 1	HITACHI HTS542580K9SA00 80G
USB 3.0 -1	USB Flash Transcend 3.0 8GB
USB 3.0 -2	USB Flash Transcend 3.0 8GB
USB 3.0 -3	USB Flash Transcend 3.0 8GB
USB 3.0 -4	USB Flash Transcend 3.0 8GB
USB 2.0-1	USB Flash ADATA 8GB
USB 2.0-2	Logitech M105 Mouse
LAN1 (I219)	1.0 Gbps
LAN2 (I210)	1.0 Gbps
Graphics Output	DVI
Power Plan	Balance (Windows10 Power Plan)
Power Source	Chroma 62006P-100-25

D.1 Intel® Core™ i7-7700@3.40GHz (8M Cache, up to 4.2 GHz)

CPU	Power Input	Power on and boot to Win10 64bit			
		Sleep Mode		idle status CPU usage less 3%	
		Max Current	Max Consumption	Max Current	Max Consumption
i7-7700	15V	0.448A	06.72W	1.623A	24.35W
i7-7700	24V	0.312A	07.49W	1.073A	25.75W
i7-7700	36V	0.240A	08.64W	0.758A	27.29W

CPU	Power Input	Power on and boot to Win10 64bit			
		Run 100% CPU usage without 3D		Run 100% CPU usage with 3D	
		Max Current	Max Consumption	Max Current	Max Consumption
i7-7700	15V	3.932A	58.98W	15.064A	225.96W
i7-7700	24V	2.496A	59.90W	9.323A	223.75W
i7-7700	36V	1.654A	59.54W	6.236A	224.50W

D.2 Intel® Core™ i7-6700TE@2.40GHz (8M Cache, up to 3.4 GHz)

CPU	Power Input	Power on and boot to Win10 64bit			
		Sleep Mode		idle status CPU usage less 3%	
		Max Current	Max Consumption	Max Current	Max Consumption
i7-6700TE	12V	0.505A	06.06W	1.876A	22.51W
i7-6700TE	15V	0.418A	06.27W	1.435A	21.53W
i7-6700TE	24V	0.295A	07.08W	0.952A	22.84W
i7-6700TE	36V	0.224A	08.08W	0.702A	25.27W

CPU	Power Input	Power on and boot to Win10 64bit			
		Run 100% CPU usage without 3D		Run 100% CPU usage with 3D	
		Max Current	Max Consumption	Max Current	Max Consumption
i7-6700TE	12V	3.508A	42.10W	18.230A	218.76W
i7-6700TE	15V	2.894A	43.41W	14.396A	215.94W
i7-6700TE	24V	1.827A	43.85W	8.925A	214.20W
i7-6700TE	36V	1.249A	44.96W	6.054A	217.94W

E

APPENDIX E : Supported Memory & Storage List

E.1 Suooprted Memory List

Testing Board	RCS-9000F GTX1080
Memory Test	version : 5.1
BurnInTest	V8.1

E.2 Test Item

Channel	Memtest	Bunin	Flash	Remove Battery
BIOS	Remove Battery	PASS	PASS	PASS
*2	PASS	PASS	PASS	PASS
*1 (Socket 1)	PASS	PASS	N/A	PASS
*1 (Socket 2)	PASS	PASS	N/A	PASS

E.3 NON-ECC

Brand	Info	NOTE & S/N	Test Temp. (Celsius)
Kingston 16GB 2Rx8 2Gx64-Bit PC4-2133	KVR21S15D8/16	BKMM1661618	25°C
		BKMM1641607	25°C
Memxpro 4GB DDR4-2133-15 Wild Temp.	D4S4GHIOFEI	01611170040001	25°C
		01611170040002	25°C
Memxpro 8GB DDR4-2133-15 Wild Temp.	D4S8GHIOFFI	01611150020001	25°C
		01611150020002	25°C
Memxpro 8GB DDR4-2400-17 Wild Temp.	D4S8GHLPGEI	01611170030001	25°C
		01611170030002	25°C
Memxpro 16GB DDR4-2400-17 Wild Temp.	D4SAGHLPGFI	01611150030001	25°C
		01611150030002	25°C
Memxpro 16GB DDR4-2400-17	D4SAGHLPGFC	01611150030003	25°C
		01611150030004	25°C
Memxpro 8GB DDR4-2400-17	D4S8GHLPGEC	01611170030003	25°C
		01611170030004	25°C
Memxpro 8GB DDR4-2133-15	D4S8GHIOFFC	01611150020003	25°C
		01611150020004	25°C
Memxpro 4GB DDR4-2133-15	D4S4GHIOFEC	01611170040003	25°C
		01611170040004	25°C
Apacer 8GB DDR4-2400 Wild Temp.	75.CA4GJ.G010B	201646411081	25°C
Apacer 16GB DDR4-2400 Wild Temp.	75.DA4GJ.G010B	201646411074	25°C

E.4 ECC

Brand	Info	NOTE & S/N	Test Temp. (Celsius)
Transcend 8GB ECC Wild Temp.	8G 2Rx8 DDR4 2133 ECCSO	C96644-0001	85°C
		C96644-0002	85°C

E.5 Supported Storage Device List

Brand	Info	NOTE & S/N	Test Temp. (Celsius)
mSATA	Intel	Intel-310 SSDMAEMC080G2	80GB
	Silicon Power	SP128GIMSA301SW0	128GB
SATA SSD	Transcend	SSD370 TS64GSSD370	64GB
	Memxpro	SSD M3A MI3MA1212802WN	128GB
		SSD M3A MI3MA1225604WN	256GB
		SSD M3A MI3MA1251208WN	512GB
	innodisk	3MR3-P DRS25-64GD70BCAQC	64GB
	Silicon Power	SP128GISSD301RW0	128GB
		SP32GISSD301SV0	32GB
SATA HDD	TOSHIBA	MK5055GSX	500GB
M.2 SATA SSD	Memxpro	M3B MD3MB1164GS1WN	64GB
		M3B MD3MB1164GS1SN	64GB
		M3B MD3MB11128D2WN	128GB
		M3B MD3MB11128D2SN	128GB
		M3B MP3MB12256S4WN	256GB
		M3B MP3MB12256S4SN	256GB
M.2 PCIe	Memxpro	ME4ME01128D4SN-M0	128GB
		ME4AE02128D4SNR	128GB
CFast	Transcend	CFX600	32GB
	Silicon Power	SP128GICFX311NV0	128GB

F

APPENDIX F : Power Supply Installation

Test Temperature (based on 95% Humidity)	30°C	35°C	40°C	45°C	50°C	55°C	60°C
3DMARK 11 (V1.5.5.0)							
Resolution	1920 x 1080						
Score	X9489	X9465	X9414	X9233	X9014	X8839	X8521
Highest Temperature	77°C	83°C	86°C	92°C	94°C	95°C	95°C
Power Status							
On	PASS	PASS	PASS	PASS	PASS	PASS	PASS
Off	PASS	PASS	PASS	PASS	PASS	PASS	PASS

Testing Equipment

CPU : Intel® Core™ i7-7700
 IMB : RCS-9000F GTX1080
 Memory : MEMXPRO 8GB*2

F.1.1 HEP-600-24 Adapter AC Cable



F.1.2 HEP-600-24 Adapter DC Cable

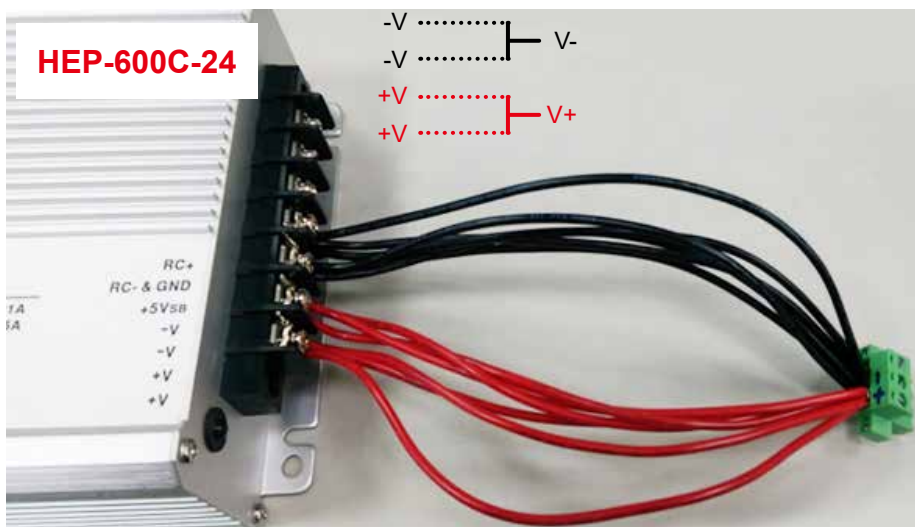

F.2.1 PWS-600W Adapter AC Cable



Adapter (PWS-600W) Input	AC Power Cord
L	BLACK
N	WHITE
⊥	GREEN

F.2.2 PWS-600W Adapter DC Cable

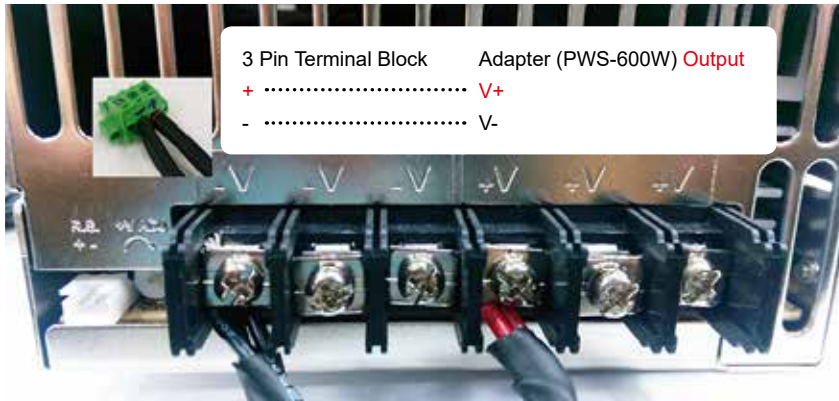

3 Pin Terminal Block	Adapter (PWS-600W) Output
+	V+
-	V-

F.3.1 PWS-480W Adapter AC Cable

Adapter (PWS-480W-WT) Input	AC Power Cord
BROWN	BLACK
GREEN/YELLOW	GREEN
BLUE	WHITE



F.3.2 PWS-480W Adapter DC Cable

3 Pin Terminal Block	Adapter (PWS-480W-WT) Output
+	BROWNx2
-	BLUEx2



F.4.1 PWS-360W Adapter AC Cable

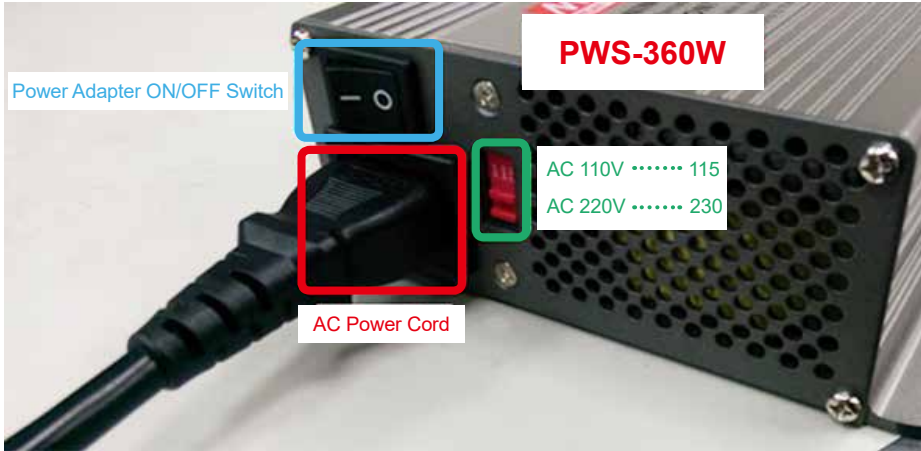

F.4.2 PWS-360W Adapter AC Cable

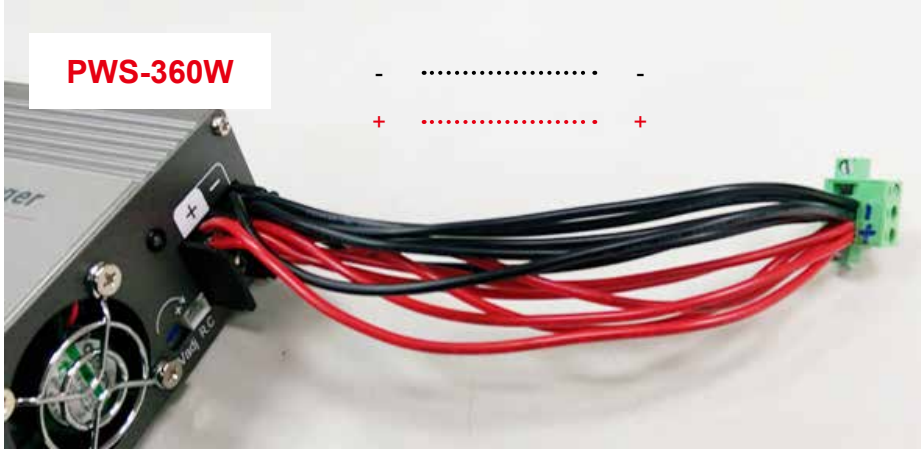

** If more help is needed, please contact Vecow technical support **



For further support information, please visit www.vecow.com

This document is released for reference purpose only.

All product offerings and specifications are subject to change without prior notice.

No part of this publication may be reproduced in any form or by any means, electric, photocopying, or recording, without prior authorization from the publisher.

The rights of all the brand names, product names, and trademarks belong to their respective owners.

© Vecow Co., Ltd. 2021. All rights reserved.